

**Netti**<sup>®</sup>  
BY ALU REHAB

*Enable joy of life*



My-Netti.com



*Enable joy of life*

# The story of Netti

The story of Netti begins in the late 1980s, where a group of friends on the Norwegian west coast came to the conviction: "This can be improved!" A friend was wheelchair bound and they were touched by the challenges the family and wheelchair user were facing daily. They therefore began developing a completely new chair with sophisticated adjustments focusing on a comfortable seating position. With mutual help and the inspiration and ideas from the family they developed a chair with innovative solutions.

Through support and relief of body strain the chair gave the wheelchair user a sense of well-being. The effect of all these relief features increased the user's joy of life to such a degree that the decision was made to establish Alu Rehab to offer other wheelchair users the same sitting comfort and joy of life. Netti by Alu Rehab was established in 1989.

Since then, our main focus has been increasing the joy of life for the wheelchair users. All our products are designed to enable and enhance mobility and to allow mastery of daily activities. Getting a good, comfortable seating position enables you to improve for instance the eating, breathing and drinking abilities as well as communication and being more independent. The better and longer you can sit in the wheelchair, the more time you can spend with friends and family - and that's what makes life great.

Netti offers high quality solutions for long time seating and is one of the few providers in the area of dynamic seating and in the field of users with complex demands.







**STEP 1:**  
**UNDERSTANDING**

Get an understanding of all the factors which the different symptom patterns and diseases have on the sitting posture.

**STEP 2:**  
**OBSERVATION + ASSESSMENT**

Closely observe the user and possibility for improved sitting posture.

**STEP 3:**  
**STRATEGY + GOALS**

Set measurable goals for improved sitting posture.

**STEP 4:**  
**CONFIGURATION**

Develop a solution and strategy for this particular sitting solution.

**STEP 5:**  
**EVALUATION**

Were the measurable goals achieved? If not, try to understand why and, if necessary, choose a new strategy.



# How to secure a great seating experience for the user?

When searching for a good wheelchair solution, the first question to appear is: Where do I start? We have made it easy for you. Together with Bart Van der Heyden - an independent physical therapist specialized in wheelchair seating and mobility - we have created five steps to an optimum seating solution!

## 5 Seating STEPS



We are happy to tell you more about the ideas behind and show you the tools, you can use in your daily work. Please contact us for a Netti Campus training session.

# CONTENTS

The Netti products at a glance

10

## NETTI 4U

Simple, lightweight solutions

The models in the Netti 4U family comprise entry models and comfort wheelchairs for the more demanding user.

**The family consists of:**

Netti 4U CE  
Netti 4U CE Plus  
Netti 4U CED  
Netti 4U CED XL  
Netti 4U Base

23

## NETTI III

Maximum adaptability for individual comfort

Netti III is the best solution for making adaptations and adjustments in order to achieve maximum sitting comfort.

**The family consists of:**

Netti III  
Netti III EL  
Netti III HD  
Netti III XHD

34

## NETTI MOBILE

Comfortable power wheelchair

Netti III with added power.

**The family consists of:**

Netti Mobile  
Netti Mobile Intuitive  
Netti Dynamic Mobile

40

## NETTI DYNAMIC

Comfort for users with movement disorders

The Netti Dynamic System is a highly refined, patented movement aid for users suffering from e.g. cerebral palsy or dystonia.

**The family consists of:**

Netti Dynamic Base  
Netti Dynamic CED  
Netti Dynamic III HD  
Netti Dynamic Mobile  
Netti Dynamic S





46

## NETTI KIDS

Maximum comfort for small users

High quality of comfort. Ideal for children with reduced muscle strength and associated sitting stability.

### The family consists of:

Netti Mini  
Netti Dynamic S

52

## NETTI CUSTOMIZED

Individual solutions for optimal adaptation

In cases where our standard products and accessories are insufficient for the user's needs, our team is able to individually adapt the chair or accessory.

### Examples of individual solutions:

Special adaptations  
Netti Bed  
Netti with 180° back  
Netti Front Back  
Netti Bariatric

62

## ACCESSORIES

Individual adjustment with a wide range of accessories

90

## SEAT AND BACK SYSTEMS

Ensure good pressure distribution, micro-climate and stability.

Netti seat cushions  
Netti back cushions  
Ride® Designs cushions and wheelchair backs



# Select the right wheelchair according to clinical picture

It is particularly important to select a wheelchair which matches the individual requirements of the user. The right wheelchair ensures that the user can maintain a healthy posture - even after several hours in the chair.



	Netti III	Netti III EL	Netti III HD	Netti III XHD	Netti Mini	Netti Mobile	Netti 4U CE	Netti 4U CE Plus	Netti 4U CED	Netti 4U CED XL	Netti 4U Base
Reduced mobility/ geriatric weakness	+	+	+	+		+	+	+	+	+	+
Hemiplegia	+	+	+	+		+		+	+	+	+
Multiple sclerosis	+	+	+	+		+		+	+	+	+
ALS	+	+	+	+		+			+	+	+
Huntington's chorea	+	+	+	+		+			+	+	+
Bariatric user	+	+	+	+		+		+	+	+	+
Cerebral palsy	+	+	+	+	+	+		+	+	+	+
Moulded seat required	+	+	+	+	+	+			+	+	+
Spasticity		+	+	+	+	+			+	+	+
Tetraplegia	+	+	+	+	+	+		+	+	+	+
Adolescent user	+	+	+		+	+		+	+	+	+
Need for carrying medical devices		+	+	+	+	+			+		+
Very tall user (> 195 cm)	+	+	+	+		+		+	+	+	+
Very small user (< 150 cm)					+			+	+		+

The above are only recommendations based on prior experience. The list is no substitute for a personal evaluation of the user, but should give an approximate idea. Feel free to contact us for advice. In complex cases, we can also provide on-site consultation.

- + Highly recommended
- + Recommended
- + Suitable





## Select the chair corresponding to the necessary accessories

In many cases, accessories are suitable for all Netti wheelchairs. This allows chairs to be adapted economically and easily to a new user. The following is a list of accessories which are restricted to particular products. We are always happy to provide personal advice. Give us a call.

	Netti III	Netti III EL	Netti III HD	Netti III XHD	Netti Mini	Netti Mobile	Netti 4U CE	Netti 4U CE Plus	Netti 4U CED	Netti 4U CED XL	Netti 4U Base
Head support with forehead strap	+	+	+	+		+	+	+	+	+	+
Height-adjustable push handles/ bar	+	+	+	+	+		+	+	+	+	+
Seat tilt limiter	+	+	+				+	+	+	+	
Seat tilt lock	+		+								
Universal device rack		+	+	+	+	+					
One-hand brake	+	+	+								
Aluminium back	+	+	+	+					+		
Belt harness	+	+	+	+	+			+			
Complete Dynamic System			+			+			+		+
Netti dynamic components	+	+	+	+	+	+			+	+	+
Reinforced tray	+	+	+	+	+		+	+			
Hemiplegia arm support	+	+	+	+	+		+	+	+	+	+
Amputation support	+	+	+	+	+		+	+			
Foot box	+	+	+		+	+			+	+	

 Available

Some solutions are available as special adaptation for other wheelchair models. Please contact us for further information.



## Lightweight and narrow

The total width of the 4U wheelchairs is very narrow and is only 18 cm wider than the seat width - 19.5 cm with drum brake. Furthermore the chair itself has a very low weight.

All 4U wheelchairs are easy to operate, as all operating points are optically marked in red. In addition, all 4U wheelchairs have a forward-hinged knee lever brake to make getting in and out of the chair even safer.

*Enable joy of life*



## **NETTI 4U CE**

Simple entry model in the comfort wheelchair range  
- ideal for geriatric patients.

See page 14



## **NETTI 4U CE PLUS**

Added value chair with extensive accessory range and high  
seat width flexibility for geriatric patients.  
First-time model for neurological disorders.

See page 16



## **NETTI 4U CED**

Design-friendly comfort wheelchair with many options up to seat  
width 60 cm. Base for the complete dynamic system.

See page 18



## **NETTI 4U BASE**

Economical frame for moulded seats and other custom solutions.  
Base for the complete dynamic system.

See page 20





	Netti 4U CE	Netti 4U CE Plus	Netti 4U CED + CED XL	Netti 4U Base
Seat widths	40, 45, 50 cm	35, 40, 45, 50 cm	35, 40, 43, 45, 50, 55, 60 cm	35, 40, 45, 50 cm
Seat width flexibility	2 x -2 cm	2 x +1 or 2 cm 2 x -2 cm	2 x +1.2 cm 2 x -1.5 cm	
Max. load	135 kg	135 kg	160 kg standard 130 kg short seat depth	125 kg
Total width	22" or 24" Standard wheels: SW + 18 cm With drum brake: SW + 19.5 cm 12" or 16" wheels: SW + 17 cm			
Seat depths	42.5 - 50 cm	42.5-50 cm standard 37.5-45 cm option	CED: 42.5-50 cm CEDs: 37.5-45 cm	42.5-50 cm
Seat heights/wheels	24+7" = 46.5 or 50 cm Optional: 22+6" = 44 or 47.5 cm 12/16"+7" = 46.5 cm	24+7" = 46.5 or 50 cm Optional: 22+6" = 44 or 47.5 cm	24+7" = 46.5 or 50 cm Optional: 22+6" = 44 or 47.5 cm 12/16"+7" = 46.5 cm	24+7" = 46.5 or 50 cm
Back height	50 cm	50 cm standard 60 cm as option	50 cm standard 60 cm as option	50 cm
Optional back extension	No	Yes	Yes	No
Seat tilt	-5° to +20°			
Back tilt	92° to 137°	90° to 135°		92° to 137°
Back unit	Fixed back unit (foam). Integrated lumbar support and side supports.	One-piece velcro back. Adjustable six-strap velcro back as option.	Six-strap velcro back. Aluminium back as option	Prepared for moulded seat solutions. Aluminium back and Netti cushions as options.
Back cushion	Integrated	Netti Uno Back standard Many Netti cushion options and Ride® Java Back.	Netti Uno Back standard Many Netti cushion options and Ride® Java Back.	Many Netti cushion options and Ride® Java Back.
Arm support	Detachable	Detachable (one-hand operation)	Revolvable (one-hand operation)	
Seat cushion	Netti Uno standard. Many cushion options - Netti and Ride® Designs.		Netti Uno standard. Many cushion options - Netti and Ride® Designs.	
Cover	Hygienic Easy Care.	Hygienic Easy Care. Breathable 3D as option	Breathable 3D Hygienic Easy Care as option	
Push handles	Pushbow standard. Adjustable pushbow as option.	Height-adjustable push handles standard. Adjustable pushbow as option.	Adjustable pushbow standard. Push handles as option.	Pushbow standard. Adjustable pushbow as option.
Adjustable extensionpieces for leg supports	No		Yes (e.g. for twisted pelvis)	
Leg supports	Angle adjustable as standard Universal leg support as option		Angle adjustable as standard Universal, dynamic or Grandis leg supports as option.	
Hemiplegia	Hemi arm support and hemi cushion as option.			
Head support	Head support A standard. Many available options: Netti and Symmetric Design.			
Dynamic options	No		Yes Components or complete	
Platform for medical devices	No		Yes	
Short description	Simple entry model, easy maintenance and operation - ideal for geriatric patients.	Added value chair with extensive accessory range, high seat width flexibility. For geriatric and first user model for neurological diseases.	Design-friendly with many options. Base for the complete Netti Dynamic System.	Economical frame for moulded seats. Base for the complete Netti Dynamic System.



## NETTI 4U FAMILY

Details make the difference!



### NETTI 4U CE

#### The simple solution

- The economical comfort wheelchair.
- Integrated back support with built-in lumbar and side supports.
- Hygienic Easy Care cover.



### NETTI 4U CE PLUS

#### A plus benefit for individuality

- Numerous back cushion variants with up to 60 cm back height.
- Adjustable six-strap velcro back as an option.
- 5 seat widths possible with one frame (8 cm seat width flexibility).
- One-hand arm support system.
- Push handles height-adjustable.
- Hygienic Easy Care cover as standard, breathable 3D cover as option.



### NETTI 4U CED

#### Numerous accessory options

- Backrests with height-adjustable back cushion and adjustable six-strap velcro for accurate fit.
- Revolvable arm support with depth-adjustable armpad allows the user to sit closer to the table.
- Simply adjusted pushbow.
- Base for the complete Netti Dynamic System.
- Netti Dynamic components can be selected.



### NETTI 4U BASE

#### For moulded seat solutions

- For moulded seats and other individual seat and back systems.
- Can also be fitted with Netti or Ride® Designs solutions.
- Base for the complete Netti Dynamic System.
- Netti Dynamic components can be selected.

# NETTI 4U CE

## The simple solution

The Netti 4U CE is the economic version of the Netti 4U CE Plus model with the same weight and narrow overall width. The chair is easy to push and manoeuvre, even in narrow spaces. It has a back unit with integrated back support with built-in lumbar and side supports.

**C** OMPACT  
**E** ASY-TO-USE



### HYGIENIC EASY CARE COVER

Supplied with the hygienic, easy-to-clean Easy Care cover. The chair is thus suitable for use in hospitals and institutions with multiple users.

### FLEXIBLE SEAT DEPTH

The seat depth can be simply adjusted without swapping parts. Each chair can be adjusted by a whole 7,5 cm in depth by simple adjustment of the backrest hinge joints.

### INTEGRATED LUMBAR SUPPORT

The back cushion is ergonomically shaped, and the integrated side supports keep the torso stable.

### SEATING POSITIONS

Back angle adjustment up to 45° and seat tilt up to 20° allow plenty of room for variable seat positions. To facilitate transfer, the seat can be tilted 5° forward.



40-50 cm

Seat width



42.5-50 cm

Seat depth



50 cm

Back height



46.5-50 cm

Seat height

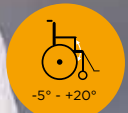

-5° - +20°

Tilt



92°-137°

Back angle



135 kg

Max load



28-32 kg

Weight



Max. 135 kg

Crash tested



Designed in Norway



# NETTI 4U CE PLUS

## A plus benefit for individuality and user friendliness

The Netti 4U CE Plus chair combines economics and individuality on a very high level. The wheelchair meets various requirements from the user due to the design of the frame and the large selection of accessories. A Plus benefit for individuality.

**C** OMPACT  
**E** ASY-TO-USE  
**PLUS**



### LIBERTAS BACK

With a Libertas back, wheelchair users are able to make small stretching movements in the torso and thus satisfy their natural urge to change their position. This considerably minimises the tendency to slide forward.



# NETTI 4U CE PLUS

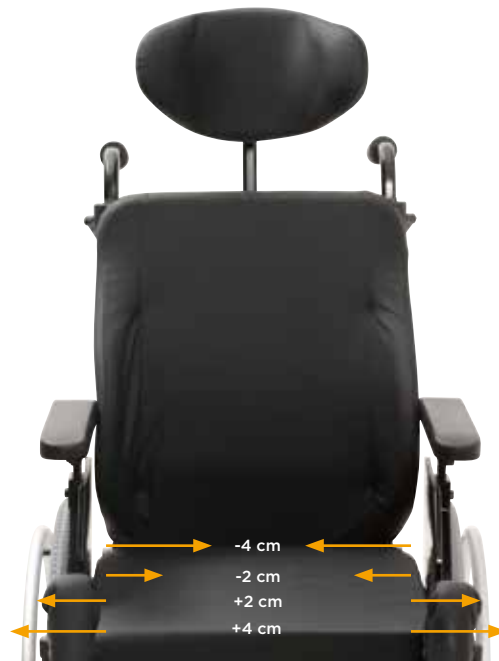

## 8 cm seat width flexibility

5 seat widths in one frame, +/- 2 or 4 cm in width. This increases flexibility of use and reduces your warehousing costs.



## One-hand armrest system

The CE Plus armrest offers maximum stability and a greater degree of user-friendliness. Simple attachment and detachment with one hand.



## Hygienic Easy Care cover

The Netti 4U CE Plus is supplied with the hygienic, easy-to-clean Easy Care cover. The chair is thus suitable for use in hospitals and institutions with multiple users. Breathable 3D covers are available as an option.



## Flexible back solution

Netti 4U CE Plus has a one-piece velcro back solution, allowing you to choose from our large selection of back cushions. An excellent solution for individual adaptation for the user. Adjustable 6-piece velcro back and a back height extension are also available as an option for this wheelchair.



35-50 cm

Seat width



37.5-45 cm  
42.5-50 cm

Seat depth



50 cm  
(60 cm)

Back height



46.5-50 cm

Seat height



-5° - +20°

Tilt



90-135°

Back angle



135 kg

Max load



27.5-29 kg

Weight



Max. 135 kg

Crash tested

# NETTI 4U CED

## Excellent ergonomic solutions and many configuration options

Narrow overall width with low total weight.  
Base for the complete Netti Dynamic System.



**C** OMPACT  
**E** ASY-TO-USE  
**D** ESIGN

### ERGONOMIC PUSHBOW

The ergonomic pushbow with adjustable angle allows an attendant to stand close to the user's body. The pushbow is quick and easy to adjust in height and can thus be adapted to the height of the attendant.

### SHORT SEAT DEPTHS POSSIBLE

A seat depth of 37.5 cm is possible for small persons. The seat depth of all chairs can be adjusted by 7.5 cm without change of components.

### FLEXIBLE SEAT WIDTH

The seat width 35, 40, 43 and 45 cm can be expanded by +1.2/2.4 cm with a seat width expansion kit. All seat widths can be reduced by -1.5/3 cm with the use of reduction pads.

### ADJUSTABLE VELCRO BACK

Netti 4U CED comes with the adjustable 6-piece velcro back as standard.

# NETTI 4U CED



## Flexible arm support

When not in use, the arm support can be folded up to facilitate side and sling transfer. The position of the armpad can easily be adjusted forwards or backwards into the ideal position, whether the user is in the chair or at a table or wishes to exit the chair.



Seat width



Seat depth

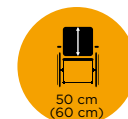

Back height



Seat height



Tilt



Back angle



Max load



Weight



Crash tested



DYNAMIC



## Also available as complete dynamic

With the Netti Dynamic System, the Netti 4U CED becomes the ideal wheelchair for users with extension movements. The wheelchair adapts itself to the user and is subject to lower pressure loading during spasms or contractions.

Back, seat unit and if needed the head support and foot supports absorb the user's extension movements.

## Universal device basket

Allows the flexible use of various medical devices or other cargo.



## Firm aluminium back unit

For users who need a firmer backrest, an aluminium back with a height of 50 or 60 cm is available.

## Footbox option

Recommended for restless users. Foam padded with sturdy, easy-clean Skai artificial leather cover.

Use of special locking brackets facilitates the attachment and detachment of the foot box.



## Available in XL

To ensure that larger people do not miss out on optimum comfort, Netti 4U CED is also available in seat widths 55 and 60 cm. The chair's light weight makes it easy to push and manoeuvre.



## Extenders for leg length compensation

Recommended for hip asymmetry or pelvic rotation. Adjustment up to a length of 10 cm.



# NETTI 4U BASE

Ideal for moulded seats  
with all the benefits of a Netti wheelchair

The Netti 4U Base has been developed to permit the optimum solutions for various seat systems, including moulded seats. The back tubes are designed to allow easy mounting of most of the seating system solutions, including the Netti cushions.



35-50 cm

Seat width



42.5-50 cm

Seat depth



50 cm

Back height



46.5-50 cm  
Without cushion

Seat height



-5° - +20°

Tilt



92°-137°

Back angle



125 kg

Max load



28-29.5 kg  
Without cushion

Weight



Max. 125 kg

Crash tested



DYNAMIC



# NETTI 4U BASE



## Multiple seat unit options

The backrest design supports many different solutions - moulded seats as well as Netti and Ride® Designs solutions.



## Flexible arm supports

The arm support can be folded up. The position of the armpad can be pushed forwards or backwards at the press of a button in order to achieve an optimum position.



## Prepared for moulded seats

Round back tubes with standard dimensions ensure that all kinds of customer-specific seating systems can be supported.



## Also available as complete dynamic

With the Netti Dynamic System, the Netti 4U Base becomes the ideal wheelchair for users with extension movements. The wheelchair adapts itself to the user and is subject to lower pressure loading during spasms or contractions.

Back, seat unit and if needed the head support and foot supports absorb the user's extension movements.



A scenic autumn path with trees and a railing. The path is paved and covered with fallen leaves. The trees are in various stages of autumn, with some showing bright yellow and orange foliage. A metal railing runs along the left side of the path. The background shows a clear blue sky and more trees in the distance.

## Maximum adaptability for individual solutions

When supplying a comfort wheelchair, you will be met with multiple demands from the user, the user's family, therapists or caretakers. The Netti III Family is the product range with the most options, making it possible to meet even complex demands.

*Enable joy of life*



## **NETTI III**

Basis for individual solutions.

See page 26



## **NETTI III EL**

Electric control of tilt, recline and leg supports.

See page 28



## **NETTI III HD**

Extra load capacity and many extra features.

See page 30



## **NETTI III XHD**

Capacity for extra heavy loads up to 200 kg.

See page 32







	Netti III	Netti III EL	Netti III HD	Netti III XHD
Seat widths	35, 38, 40, 43, 45, 50 cm	35, 38, 40, 43, 45, 50, 55, 60 cm	35, 38, 40, 43, 45, 50, 55, 60 cm	50, 55, 60 cm and 65, 70, 75 cm
Seat width flexibility	Extension kit for seat width 35-45 cm: 1.2 cm per side. Reduction by side pads: 2.5 cm per side		Extension kit for seat width 35-45 cm: 1.2 cm per side. Reduction by side pads: 2.5 cm per side	Reduction by side pads: 2.5 cm per side
Max. load	145 kg	145 kg / 160 kg	160 kg	200 kg
Total width	Seat width +22 cm For 12"/16": Seat width +19 cm		Seat width +22 cm For 12"/16": Seat width +19 cm	Seat width +24 cm For 12": Seat width +21 cm
Seat depths	40-50 cm	40-50 cm Up to 57.5 cm as option.		40-50 cm
Seat heights/wheels	24+7" = 46 or 49 cm Possible with optional wheels: 40.5 to 51.5 cm			24+8" = 47.5 cm 12+8" = 48.5 cm
Back height	50 cm standard 60 cm as option			
Seat tilt	-9° to +16°		Double gas cylinder -9° to +16° -10° to +35° as option	Double gas cylinder -9° to +16°
Back tilt	86° to 133°		Double gas cylinder 86° to 133°	Double gas cylinder 86° to 133°
Back unit	Standard: Adjustable 6-piece velcro, Options: High back, fixed aluminium back			
Back cushion	Standard: Netti Smart Options: Netti Stabil, Super Stabil, Kyphotic, Ride® Java Back			Standard: Netti Stabil Option: Netti Super Stabil
Seat cushion	Standard: Netti Uno Seat Options: Netti Sit, Ride® Java, Ride® Forward	Standard: Netti Uno Seat up to sw 50 cm Options: Netti Sit, Ride® Java, Ride® Forward  Netti Sit for seat width 55 and 60 cm		Netti Sit Options: VB Venti and Royal (for certain seat widths only)
Seat plate	Sliding seat plate Option: comfort plate			Reinforced seat plate
Cover	3D breathable textile cover Hygienic Easy Care as option up to seat width 60 cm			
Push handles	Standard: Height-adjustable push handles. Option: Adjustable pushbow			
Extension pieces for leg supports	Adjustable extension pieces for leg supports (e.g. for twisted pelvis)			
Leg supports	Standard: Angle adjustable Options: Grandis positioning leg support, universal and dynamic leg supports. Footboard, amputation support and footbox.		Standard: Grandis positioning leg support Options: angle adjustable, universal and dynamic leg supports. Footboard, amputation support and footbox.	Standard: Grandis positioning leg supports with foot plates / footboard. Options up to seat width 60 cm: dynamic leg supports, footboard, footbox.
Hemiplegia	Hemiplegia arm support and cushion possible			
Head support	Standard supplied without head support Options: Netti A-F and Symmetric Design head supports			
Electrical adjustment	No Upgrade possible	Seat tilt, back tilt and leg supports.	No Upgrade possible	
Dynamic options	Yes, dynamic components: back, leg supports and head support		Yes, dynamic components and complete system (seat, back, leg supports, head support)	
Platform for medical devices	No	Yes for aspirator, oxygen cylinder, breathing device, etc.		
Brief description	Netti III for neurological diseases, various upgrades available, good basis for progressive diseases.	Netti III EL for greater independence by means of electrical control	A solid wheelchair with extensive possibilities for individual adjustments, e.g. universal device rack.	Extra high capacity and stability. Extensive reinforcements are included and more are possible. Healthy sitting - also for XXL users.

## NETTI III FAMILY

Individual demands need individual solutions!



### NETTI III

#### Base for individual solutions

- Sliding seat plate.
- Various seat heights achievable through a large selection of main wheels and castors.
- Numerous back cushion options with up to 60 cm back height.
- Seat width flexibility possible.
- Dynamic components selectable.
- Wide accessory range with innumerable solutions.
- Low weight - easy to manoeuvre.



### NETTI III EL

#### Electrical control of all functions

- Electric leg supports.
- Electric seat angle adjustment.
- Electric back support adjustment.



### NETTI III HD

#### For special solutions & reinforced for heavy duty

- Load capacity up to 160 kg
- For special solutions such as:
  - Oxygen devices
  - Tilt up to 45° possible
  - Users with long legs - seat depth up to 57.5 cm
  - Netti Dynamic System for users with movement disorders.



Available for seat width 50-60 cm

### NETTI III XHD

#### Capacity for extra heavy duty

- Load capacity up to 200 kg.
- Seat widths up to 75 cm.

# NETTI III

## Base for unique individualisation

The Netti III family has the largest available configuration options of all the Nettis, with a wide accessory range and innumerable solutions.



35-50 cm

Seat width



40-50 cm

Seat depth



50 cm  
(60 cm)

Back height



46+49 cm  
(40,5-51,5)

Seat height



-9° - +16°

Tilt

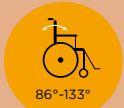

86°-133°

Back angle



145 kg

Max load



Approx. 30 kg

Weight



Max. 136 kg

Crash tested



DYNAMIC



### Dynamic back, head support and leg supports

Netti III with added dynamic components becomes the ideal wheelchair for restless users or users with movement disorders. Back, head support and leg supports can be supplied in a dynamic variant. The chair then absorbs the user's extension movements. Netti III HD is also available as complete Netti Dynamic System with a dynamic seat-plate.





## User adaptation

The Netti III has the highest number of accessories on the market. Thanks to its flexible design, it can be configured to match the user's special needs.

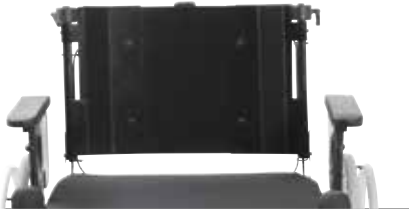

### Fixed back unit in aluminium

For users who need a firmer backrest, an aluminium back with a height of 50 or 60 cm is available.



### One-hand brake

For users who can only use the brake on one side, we offer a drum brake with cable connection to a brake operated by the user's brake. On request we can offer a mechanical central brake.



### Sliding seat or comfort plate

The sliding seat can be recommended as an aid for simple transfer and positioning of the user. The seat plate can be pulled out or pushed in while the user is sitting on the chair. This ensures that the user can be positioned correctly in the chair.

The comfort seat plate complements the pressure-relieving effect of the seat cushion and allows the pelvis to sink down further. This stabilises the seating position and prevents a tendency to slide forwards.



### Footbox with upholstery

Recommended box for restless users. Foam padded with sturdy, easy-clean Skai artificial leather cover. Use of special locking brackets facilitates the attachment and detachment of the footbox.



### Customized individualisation

Because of its flexible design, the Netti III permits individual custom adaptations. The Netti III often serves as a basis for special adaptations for users with particular requirements.

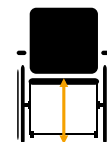

### Variable seat heights

The large selection of main wheels and front castors allows the seat height to be adjusted according to usage. Seat heights from 40.5 cm to 51.5 cm are possible.

## NETTI III EL

# The electrical solution for independence

Netti III EL is the only manual wheelchair on the market which can be fitted with electrical control of seat, back and leg support adjustment. As on the standard model, the wheelchair allows optimum individual adaptation.

### ELECTRIC



**ELECTRIC  
LEG SUPPORTS**

**ELECTRIC  
BACK ADJUSTMENT**

**ELECTRIC  
SEAT ANGLE ADJUSTMENT**



35-60 cm

Seat width



40-50 cm  
(52.5-57.5)

Seat depth



50 cm  
(60 cm)

Back height



46-49 cm  
(40.5-51.5)

Seat height



-9° - +16°

Tilt



86° - 133°

Back angle



145 kg  
(160 kg)

Max load



Approx. 39 kg

Weight



Max. 136 kg

Crash tested



DYNAMIC





# NETTI III HD

## A reinforced version of Netti III with the possibility for many special solutions

The wheelchair is approved for up to 160 kg. The chair is very stable and supplied with reinforced main wheels and front castors, double gas cylinder for seat tilt and a sliding seat plate. In case of the need for a higher capacity, the Netti III XHD is available.

**HEAVY  
DUTY**



35-60 cm

Seat width



40-50 cm  
(57.5 cm)

Seat depth



50 cm  
(60 cm)

Back height



46+49 cm  
(40.5-51.5)

Seat height



-9° - +16°

Tilt



86°-133°

Back angle



160 kg

Max load



Approx. 36 kg

Weight



Max. 160 kg

Crash tested



DYNAMIC

### HIGH COMFORT AND GOOD PRESSURE RELIEF

- Seat widths from 35 to 60 cm
  - seat width 35-45 cm can be extended by 1.2 cm per side
- Max. load 160 kg
- Double gas cylinder for seat tilting provides additional stability
- High-quality Netti Smart back cushion as standard for users with higher requirements for comfort. Ergonomically shaped and accurately positioned lumbar support and 12 cm side supports for enhanced stability of the torso.

# NETTI III HD



### Reliable and strong Grandis leg supports

Netti Grandis positioning leg supports are standard - for complex individual user solutions. Reduce pressure on ischial tuberosities and reduces sheer forces.



### 45° seat tilt

For users who often change their seating position in order to relieve pressure, we can offer Netti III HD with 45° seat tilt - i.e. 10° forwards and 35° backwards.

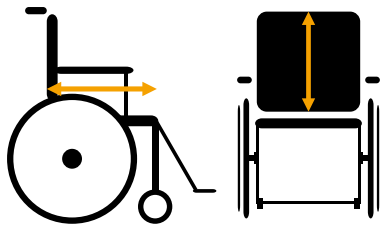

### For users needing a long seat depth or high back

For users needing a longer seat depth, the chair can be adjusted with a seat depth up to 57.5 cm. Thereby ensuring the correct seating position. The standard back extender is adjustable up to 70 cm - by adjusting the longer back cushion upwards, a complete support is achieved.



### Tilt and recline adjustable by the user

The levers for tilt and recline can be mounted on the arm support.



### Dynamic components or complete Dynamic

With the Netti Dynamic System, the Netti III HD becomes the ideal wheelchair for users with movement disorders. The wheelchair adapts itself to the user. Head support, back, seat unit and foot supports adapt themselves and absorb the extension movements.



### Universal device rack for oxygen devices etc.

For use of oxygen devices, aspirators etc. A flexible solution with secure fixing of medical devices. Compatible with most devices.

# NETTI III XHD

## Maximum pressure relief for bariatric users

XHD means extra heavy duty - the chair is tested and approved for 200 kg. The wheelchair comes with back and tilt adjustment, as users with a higher weight need to change their seating position more often in order to relieve pressure. No compromises have been made here.

**X**TRA  
**H**EAVY  
**D**UTY



50-75 cm

Seat width



40-50 cm

Seat depth

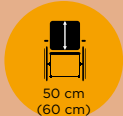

50 cm  
(60 cm)

Back height



48.5-51.5 cm

Seat height



-9° - +16°

Tilt

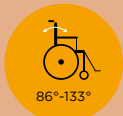

86°-133°

Back angle



200 kg

Max load



Approx. 36.2 kg

Weight



DYNAMIC

Seat width  
50-60 cm

### REINFORCED WHEELCHAIR FOR MAX. LOAD UP TO 200 KG

- Reinforced main wheels
- Reinforced front castors
- A double tilt gas cylinder increases stability
- A double recline gas cylinder increases stability
- Reinforced back hinges
- Reinforced arm support holders
- Head support stabiliser
- Skirt guard in aluminium
- Reinforced extension piece for adjusting seat depth forwards
- Reinforced complete seat plate
- Reinforced frame for stability
- Wide armrest pads (420x80 mm)
- Reliable and solid Grandis leg supports

# NETTI III XHD



**Head support stabiliser as standard**  
Ideal for higher pressure on the head support and permits the secure fastening on the back tubes to prevent the head support from twisting.

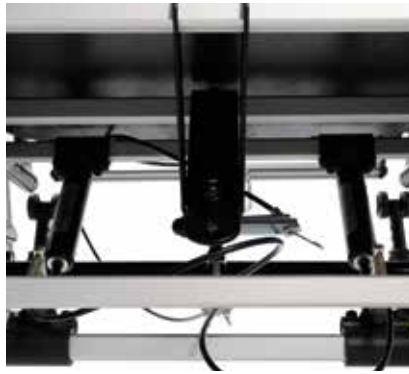

**Double tilt and recline cylinder**  
For more stability and simple handling, a second cylinder has been integrated for seat tilt as well as back recline.



**Universal device rack for oxygen devices etc.**  
For use of oxygen devices, aspirators etc. A flexible solution for secure fixing of medical devices. Compatible with most devices.



**Additional stability**  
The Netti Stabil back cushion provides additional support to the torso. 17 cm side support for greater stability. Ideal combination options with the side support Stabil.



**Reliable and solid Grandis leg supports**  
Netti III XHD comes as a standard with the Netti Grandis positioning leg supports. The leg supports help reducing pressure on ischial tuberosities and shear forces.



**Grandis footboard**  
Lockable footboard as standard from seat width 65 cm. For seat width 50-60 cm it is optional.

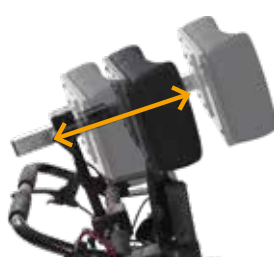

Available for seat width 50-60 cm

**Dynamic leg supports and head support**  
Foot supports and head support can be dynamic. The chair will then absorb the extension movements of the user (see page 40).



**High load capacity**  
Max 200 kg.





## Comfort with power

Like all products in the Netti family, the Netti Mobile family is highly adaptable to the users individual needs. This is especially beneficial for users with reduced mobility and limited ability of movements.

*Enable joy of life*

## **NETTI MOBILE**

An innovative power wheelchair with the superb Netti seat and back cushions.

See page 36



## **NETTI MOBILE INTUITIVE**

Intuitive attendant control without joystick, but with automatic speed adjustment.

See page 38



## **NETTI DYNAMIC MOBILE**

For users with movement disorders.

See page 39



# NETTI MOBILE

## An innovative multi-functional electric wheelchair

Mobility means the ability to participate in social life and daily activities. Imagine following a forest track or meeting friends at a café. Even longer distances are no longer insuperable. Netti Mobile is also permitted as a driver's seat in a car. That's what Netti Mobile is all about!



40-50 cm

Seat width



40-50 cm

Seat depth



50 cm  
(60 cm)

Back height



50 cm

Seat height



M: 4°, 8°, 12°  
E: -9° +16°

Tilt



88°-113°

Back angle



140 kg

Max load



94 kg

Weight



6 km  
(10 km)

Max speed



Max. 136 kg

Crash tested

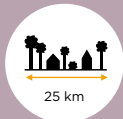

25 km

Maximum  
distance



DYNAMIC

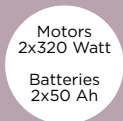

Motors  
2x320 Watt

Batteries  
2x50 Ah

# NETTI MOBILE

## Power wheelchair with the superb Netti features

- Netti seat and back cushions are ideal for users who spend a long time in their wheelchair.
- For indoor and outdoor use.
- All Netti wheelchairs are equipped with optimal solutions, e.g. an ergonomic back construction.
- As an option, seat, back and foot supports can be electrically adjustable.
- Compact and highly manoeuvrable.
- Simple to operate.

## With or without electrical functions

### **M: Manual adjustment option**

Fixed adjustable seat tilt in 3 angles: 4°, 8°, 12°. Backrest adjustment by user (gas cylinder).

### **E1: Electric seat tilt**

### **E2: Electric seat and back adjustment**

### **E4: Electric seat, back and leg support adjustment**



### **Solid and with many adjustment options**

Netti Mobile offers ergonomic solutions familiar from our other comfort wheelchairs, e.g. anatomic back support and leg support hinge joints and extenders.



### **Flexible arm support**

When not in use, the arm support can be folded up and away.



### **Good torso posture**

The adjustable velcro back supplements torso support with the back cushion. When adjusting the chair to the user, the backrest shape is modified with the 6-piece velcro back providing the best support to the user's lumbar curve and back curvature. The variable adjustment of back cushion height facilitates the best possible individual adaptation.



### **Individually customisable**

Like all Netti wheelchairs, the Netti Mobile family is highly adaptable to the user's individual needs. This is especially beneficial for users with reduced mobility, limited movements and cognitive difficulties.



### **Monopad**

As special adaptation, we offer a monopad with aluminium or padded footboard. The monopad is extraordinarily stable.



### **Universal device rack for oxygen devices etc.**

The universal and flexible solution for extending your mobility, and for safe transport of breathing devices, oxygen bottles, nutrition pumps and much more. See also page 78.



## NETTI MOBILE INTUITIVE

# Intuitive attendant control without joystick, but with automatic speed adjustment

The intuitive attendant control on the Netti Mobile Intuitive sets new standards for effortless control by an attendant.



### A SIMPLE PUSH

Push the chair slightly in the way you wish to go, just as you would with a manual wheelchair. The Netti Mobile Intuitive will effortlessly propel the chair at your speed in any direction: forwards, backwards or sideways. To stop the chair, simply remove your hands from the yellow control lever.

### FOR INDOOR AND OUTDOOR USE

The Netti Mobile Intuitive has the same powerful engines and wheels as all the other Netti Mobile wheelchairs. For you, this means that the chair can be used both indoors and in outdoor areas. Only very few attendant control systems allow this!

## NETTI DYNAMIC MOBILE

### The first power wheelchair with dynamic components

The dynamic components on the Mobile are patented and automatically adapt themselves to a user's dystonic movement pattern. The energy generated by the strong spastic movements is absorbed by the dynamic system, and returns the user, once the muscular tension has passed, to the well-adjusted seating position.

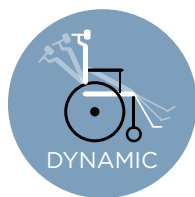

#### FOR USERS WITH MOVEMENT DISORDERS

The Netti Dynamic Mobile has been specially developed for the needs of users with impairments in the dystonic spectrum, e.g. athetotic movements of the extremities, extreme muscle tension (spasticity) or cerebral palsy. With the Netti Dynamic System, the wheelchair becomes ideal for users with movement disorders. The wheelchair adapts itself to the user. The seat and back unit, the head support and leg supports adapt themselves and absorb the extension movements securing a good seating position.

#### DYNAMIC MOVEMENT PATTERNS:

- Legs and feet
- Pelvis and hips
- Back
- Head/neck



## Freedom of movement results in a better seating position

International studies show that reducing the repositioning frequency has a relaxing effect on the wheelchair user and thereby encourages participation in daily life with family and friends.

*Enable joy of life*



## **NETTI DYNAMIC BASE**

Suitable for moulded seats and other special adapted seating solutions.



## **NETTI DYNAMIC CED**

Compact comfort wheelchair.



## **NETTI DYNAMIC III HD**

Wheelchair with wide variety of accessories.



## **NETTI DYNAMIC MOBILE**

The first power wheelchair with dynamic components.



## **NETTI DYNAMIC S**

Unique dynamic solution for children.



## Important benefits

- The user will have less discomfort during spasm as the wheelchair supports the movement
- After a spasm the user returns to his or her original seating position securing a good position and pressure distribution.
- Prevents unintentional change of position
- Prevents the user from sliding forward in the chair and thereby getting a bad seating position and bad distribution of pressure.
- Extends the life time of the wheelchair

## Target group

- Cerebral Palsy (CP)
- Spastic CP
- Dyskinetic CP
- Atactic CP
- Athetotic CP
- Dystonia
- Chorea Huntington
- Parkinson's disease
- Demential Syndromes
- Skull brain tract
- Spinal cord injuries

# NETTI DYNAMIC SYSTEM

## The dynamic components

The complete Netti Dynamic System includes as a minimum a dynamic back and a dynamic seat unit. As an option, you may choose dynamic leg supports or a dynamic head support.



### Dynamic back

The back adapts itself to both minor and major trunk extension movements up to a completely inclined back unit. The forces occurring are actively absorbed by the wheelchair.



### Dynamic seat plate

The seat plate adapts itself to extension movements at the hip. This prevents the user from sliding forwards and actively prevents a negative seating position. If the user has extension movements of the legs, this will also have an effect on the hip angle. For this reason, it is important that the seat plate is able to adapt to the movements as well.



### Dynamic head support

The head support adapts itself to the user's head movements and simultaneously dampens these by use of gas springs, while maintaining the original height and depth adjustment of the head support. This gives the user the best conditions for participating in social life. It also reduces the load on the user's head and neck.

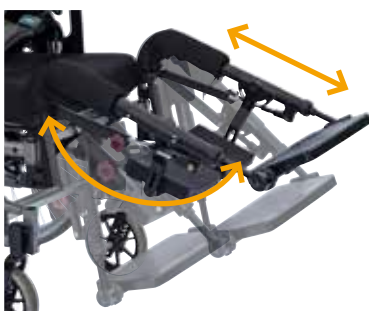

### Dynamic leg supports

The dynamic leg supports are important for the user to keep the best seating position over time. Flexible knee angle as well as flexible length and feet angle adjustment.

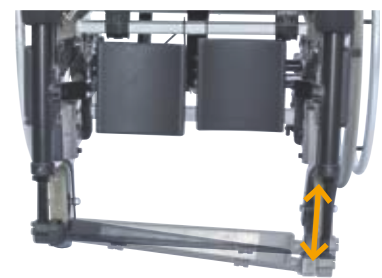



# NETTI DYNAMIC SYSTEM



**Patented solutions**



**Modular system**



**Documented effects**

## Freedom of movement enhances quality of life

Over time it can be difficult to secure users with movement disorders a good seating position in a conventional wheelchair. The risk exists that the body due to the user's extension movements will be pushed out of the wheelchair creating a unintentional seating position, shear and bad pressure distribution.

The spasms and contractions affect the user's muscle-bone-apparatus causing joint dislocations which along with the unwilling movements challenges the stabile seating position. The user will also often be needing repositioning by care givers to remain a correct seating position.

The extension movements will affect the complete wheelchair construction and challenge the strength of the wheelchair.

The Netti Dynamic System wheelchairs absorb the extension movements of the user, causing less pressure on the wheelchair construction at the same time as the seating position of the user is restored.

### **Patented system**

The Netti Dynamic System is an advanced, patented mobility aid for users affected by e.g. cerebral palsy or dystonia.

The dynamic wheelchairs follow the user's movement patterns and the user will after a spasm return to his or her previous and comfortable seating position. This causes a reduction of the higher muscle tension in the extension phase and clinical studies show, that over time many users also experiences a reduction of the occurring spasms.

International studies show that reducing repositioning frequency has a relaxing effect on the wheelchair user and thereby encourages participation in daily life with family and friends.



# NETTI DYNAMIC SYSTEM



## NETTI DYNAMIC BASE

Suitable for moulded seats and other individual solutions.



## NETTI DYNAMIC CED

Compact comfort wheelchair with many configuration options.



## NETTI DYNAMIC III HD

Wheelchair with a wide variety of accessories and configuration options.



## NETTI DYNAMIC MOBILE

The first power wheelchair with dynamic components.



## NETTI DYNAMIC S

Unique dynamic solution for children.

**Netti** III  
COMFORT

**Netti** 4U CED  
COMFORT

**Netti** III HD  
COMFORT

**Netti** 4U Base  
COMFORT

**Netti** III XHD  
COMFORT

**Netti** Mobile  
COMFORT

## DYNAMIC COMPONENTS

The dynamic components can for selected wheelchairs be used as single components according to the movement pattern of the user and the given objective of the wheelchair supply.

## Healthy seating for children

When supplying wheelchairs for children and adolescent, we face very specific challenges. Through the innovative concept of our wheelchairs and the numerous configuration possibilities, we are able to meet the individual demands and also accommodate the wishes from the parents and the therapists.

*Enable joy of life*



## **NETTI MINI**

Comfort wheelchair for children.

See page 48



## **NETTI DYNAMIC S**

Dynamic comfort wheelchair  
for children with movement disorders.

See page 50



# NETTI MINI

## Maximum comfort for small users

Netti Mini is a high-comfort chair which is ideal for children and adolescents with reduced stability and muscle power who need a chair which gives the body plenty of support. The wheelchair's many adjustment options and numerous accessories permit an enhanced level of activity, while preventing faulty posture and asymmetry for the child.

For transport, the Netti Mini can be used as a car seat.



### DRUM BRAKE

As standard, Netti Mini is supplied with a drum brake for the attendant.

### SITTING VARIATION

Adjustment of the seat and back angle enables the seat position to be changed and offers pressure relief during activity, rest and transfer.

### FLEXIBLE ARMREST

The arm support is height-adjustable and can be completely detached.

### EASY PUSHING

A negative camber of 4° improves stability as well as driving and handling.



25, 30, 35 cm

Seat width

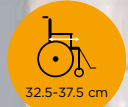

32.5-37.5 cm

Seat depth



40 cm

Back height

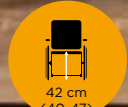

42 cm  
(40-47)

Seat height



-7° - +23°

Tilt



87°-120°

Back angle



90 kg

Max load



Approx. 25 kg  
Without cushion

Weight



Max. 75 kg

Crash tested



# NETTI DYNAMIC S

## Healthy seating for children with movement disorders

The solution for complex movement patterns in the childcare segment. Attractive design combined with high functionality.

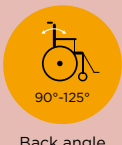
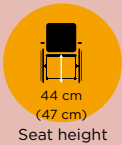
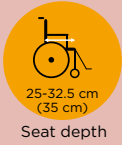

### Five dynamic functions

- Hip
- Back
- Leg length
- Knee angle
- Foot angle



### Out and about

We have designed special accessories e.g. the Netti Nature Buggy wheel and a hood to protect from wind, rain or impressions (Netti Customized accessories). With these accessories we are giving the user and the relatives an even greater opportunity to take part in all aspects of everyday life.

# NETTI DYNAMIC S

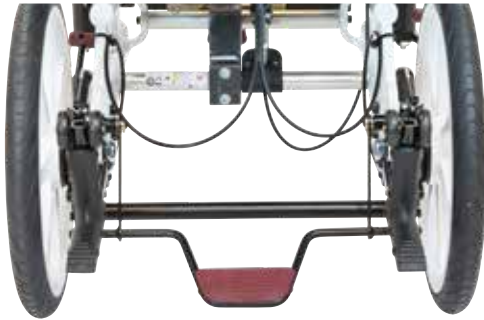

### Easy Brake

Combined central brake, that can be operated by foot or hand.



### Height-adjustable push-bar

Easily adjusted in height with the release lever.



### Flexible seat plate

The chair can be adjusted by 10 cm in depth (from 25 to 35 cm without further parts), thus ensuring seating comfort for growing children.



### Side supports for stability

Adjustable in height and side adjustable.



### Read-off seat tilt

Manual seat tilt for varying the seating position.



### Simple folding

If you wish to transport the chair in folded state, this is easily achieved.

# Adapting the wheelchair to the user - and not the other way round

We have years of experience in individual solutions. In cases where our standard products and accessories are insufficient for the user's needs, our team of experienced technicians and ergotherapists is able to individually adapt the chair or accessory.

*Enable joy of life*



## INDIVIDUAL CUSTOMISATION

Individually constructed chairs and accessories.

See page 54

### NETTI BED

For users who are mobilised in lying position.

See page 56

### NETTI III EL 180° RECLINE

For users with need of rest and relaxation.

See page 58

### NETTI FRONT BACK

For users with a high level of activity despite physical limitations.

See page 59

### NETTI BARIATRIC

For bariatric users with seat widths up to 100 cm and user weights up to 450 kg.

See page 60



## Individual customisation

Here are a few examples of individually adapted chairs and accessories. We are happy to work with you to create individual, customised solutions.



Divided footbox



Footbox with build-in division



Footbox with lower leg fixation



Padded half-tray with side support



Long calf support with straps



Head support with adjustable side support on one side



# NETTI CUSTOMIZED

---



## Wheelchairs with extensive padding

All parts of the frame are padded in order to rule out the risk of injury to the user.



## Wheelchairs for very small users



## Chair with various custom solutions

Wheelchair with padding in the seat and back region and a padded footbox. A possibility for users who cannot bend their legs.



## All-round wheelchair with seat tilt

Netti II with seat tilt operable by the attendant or by the user. For the user, this chair will be experienced as a very easily handled comfort wheelchair.



## Wheelchair for a user with body asymmetries

Extra side supports have been fitted on the left in order to relieve the back, while on the right, extra padding has been used. Extended support for the upper left extremity and head. Soft padding on the right side.



## Chair with various custom solutions

Foot supports, abduction block and tray have been installed in a customised version.



## NETTI CUSTOMIZED

For persons who can only be mobilised  
in a lying position

Netti Bed is based on the Netti III frame with the length and width individually adapted. Netti Bed is available in many different configurations, e.g. with 2- or 3-part lying unit and electrical functions.



 **Netti**® Bed  
COMFORT

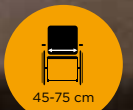

45-75 cm

Seat width



175-200 cm

Length



As requested

Back height



75 cm

Seat height  
standard

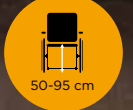

50-95 cm

Seat height



As requested

Max load

## NETTI CUSTOMIZED

---

### Netti III EL with 180° backrest recline



For users with a strong need for different back angle adjustments and resting phases. This configuration saves the user excessive transfers between bed and chair. As a result, despite a reclining position, the user can remain mobile and participate in social relations.



### Front back drive

The chair is suitable for indoor use with narrow passages and door thresholds, which it overcomes with ease.



### **Netti**® Front Back

---

The Netti Front Back is constructed for users who despite severe physical disabilities have a high level of self-activity. Even with a strong kyphosis the user is able to drive the chair himself. The low seat height and the free space under the chair allows for propelling the chair with the feet. The chair is compact and easy to manoeuvre.

The back recline can be operated by the user or the attendant. The seat tilt function is also available as electric adjustable.

User profile:

- Extreme hyperkyphosis
- Contractions in the shoulders
- Hip contractions

## NETTI CUSTOMIZED

### Individual adaptation for obese users

Our experienced technicians and consultants are able to adapt wheelchairs to meet most needs. For instance, Netti offers reinforced wheelchairs up to seat width 100 cm and for user weights up to 450 kg. The wheelchairs 450T and 450F are designed for this.

The chairs are built for high user weight, but it is also important that the back and seat unit can be precisely adjusted to the body, as many obese persons have back problems.

The Netti Seating Solution is designed to cope with high user weight and optimum pressure distribution. We offer also an electric variant, in which the seat and back can be adjusted separately.



Seat width



Max load



 **Netti**<sup>®</sup> Bariatric  
COMFORT

#### Netti 450T

Seat tilt, legs and back support electrically adjustable.

#### Netti 450F

Back support manually adjustable in three different angles

# NETTI CUSTOMIZED

## Cooperation for optimum results

Our team of experienced technicians, therapists, sales representatives and customer service employees will help you find, describe and produce the right solution which provides the user with the proper care.

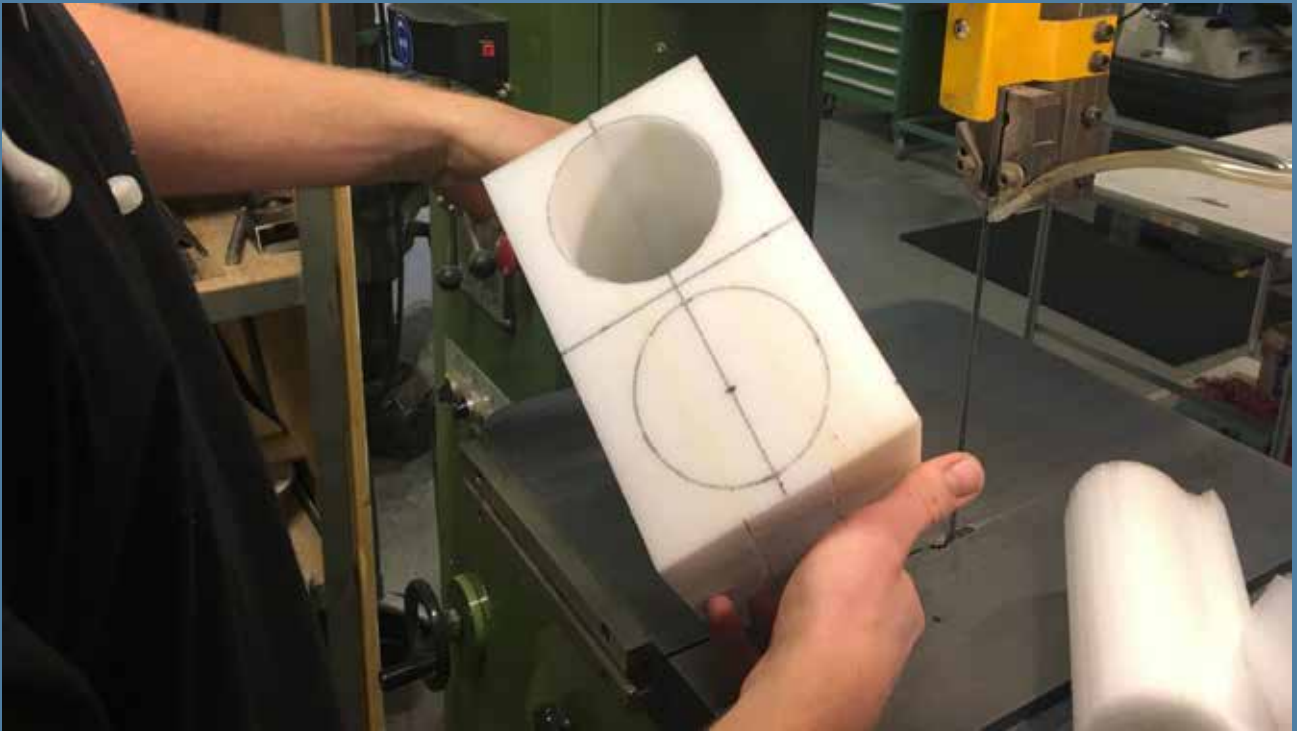



A low-angle photograph of a forest path. The path is covered in fallen leaves and leads into a dense forest of tall, thin trees. Sunlight filters through the canopy, creating a bright, hazy glow in the center of the image. The overall mood is serene and natural.

## Adapt the chair with accessories

Our accessories program for Netti wheelchairs is unique. With a Netti wheelchair, you are never tied to one solution but can configure a chair with our standard and customised accessories and match them to whatever needs the user might have.

*Enable joy of life*

Leg supports.....	64
Stabilising the pelvis.....	66
Arm support.....	69
Back unit.....	70
Stabilisation of torso.....	71
Head supports.....	72
Accessories for greater independence.....	74
Electrical functions.....	75
Netti out and about.....	77
Universal device rack.....	78
Brakes and brake handles.....	79
Push handles and push bows.....	80
Trays for activity and relief.....	81
Rim controlled drive unit.....	82
Pressure measurement.....	87
Ramps.....	88

## New cooperation partners



### Power units

With the driving units from Decon, you can turn your Netti wheelchair into a compact power wheelchair. E-Move for push rim controlled driving and E-Drive for joystick/attendant control.

Read more about E-Move on page 82 and E-Drive on page 84.



### Savant head support and Axion head support adapter

The Symmetric Design Savant head support is a customisable support for the head. It is light-weight and can easily be shaped by hand. The Axion head support adapter has a rotation possibility of either 60° or 90°.



### XSensor pressure imaging system

Prevent pressure ulcers with reliable data. See page 86.

## Leg supports

The good fitting of a wheelchair always starts with the legs. The leg supports are the foundation of the wheelchair supply. They are the base for creating the optimal seating position and necessary in order to remain this position over time. Therefore you will find many solutions for the leg support in order for you to meet the individual demands of the wheelchair user.



### Grandis positioning leg supports

For all Netti chairs with replaceable extension pieces. Netti Grandis positioning leg support reducing pressure and shear forces. Distinguished by simple handling due to handles, read-off scales and cone-shaped extension pieces. Angle-adjustable, including angle limiter and multi-adjustable calf and foot supports.

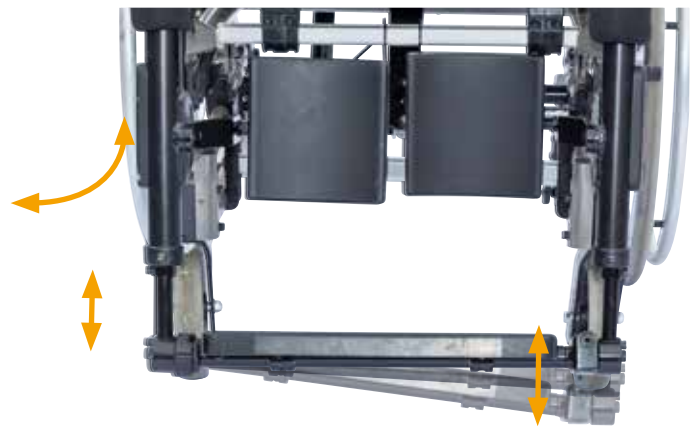

### Dynamic leg supports

For Netti III and Netti Mobile family, Netti 4U CED, Netti 4U Base and Netti Dynamic family. The dynamic leg supports are highly important for allowing users to assume a correct seating position over time. Flexible knee angle, length and foot position.



### Fixed leg supports

For Netti Mobile. These leg supports have a fixed angle of 110° and are always supplied with heel straps.



### Angle adjustable leg supports

Our angle adjustable leg supports have an ergonomic design and automatic leg length compensation.



### Universal leg supports

The universal leg supports have stepless angle adjustment and are a good solution for users with contracted knees, as the leg support can be adjusted below 90°.



### Electric leg supports

For Netti III and Netti Mobile family. Footbox and footboard is also possible.



## NETTI ACCESSORIES



### Calf support with hinge

The calf support can be swung back at the hinge joint if necessary. Recommended for users with stiff leg muscles, e.g. stiff femoral muscles



### Calf plate pads

For users with very sensitive and easily injured skin, padding for the calf plate is available.



### Foot plate upholstery

For most leg support solutions, soft footplate padding is available for persons who do not wear shoes or who are sensitive to pressure.



### Calf support bracket pad

For users with very sensitive and easily injured skin, padding for the angle is available.



### Heel strap

If ankles and feet need a better posture, heel straps can be mounted on the angle adjustable leg supports. Similarly, foot fixation straps can fix ankles and feet over the instep.



### Foot fixation strap

The foot fixation strap is for discreet stabilisation of the feet to prevent the forward sliding (e.g. for plantar flexion).



### Ankle huggers

The ankle huggers are for stabilisation of the feet - still allowing the user certain movement possibilities (e.g. for hypertonic movement disorders, flexible ankle deformities).



### Body point calf strap

The calf strap offers the lower legs a flexible and large support area. Thereby the needed stability can be achieved and pressure points can be prevented.



### Amputation support for angle adjustable / Grandis leg supports

Angle adjustable amputation support with height and depth-adjustable calf support. The amputation support is used for amputations below the knee, where support is necessary.



### Foot box for angle adjustable and Grandis leg supports

Recommended for restless users. Foam padded with sturdy, easy-clean Skai artificial leather cover. Use of special locking brackets facilitates the attachment and detachment of the footbox. Spacers for steering wheels are recommended in this case.



### Footboard for angle adjustable and Grandis leg supports

A very stable, easily mounted footboard. When not in use, it may be folded up and locked.

## Stabilising the pelvis

The biggest challenge for the wheelchair supply is to prevent sliding or deviation of the optimal seating position over time. The resulting risk for the therefrom following consequences or injuries (e.g. decubiti) makes the stabilisation of the pelvis so extremely important.

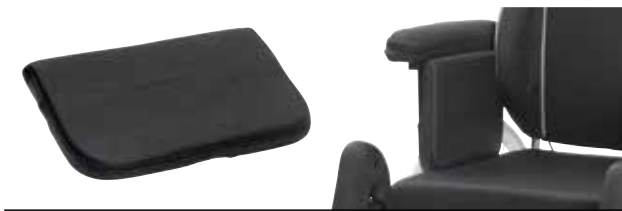

### Comfort pads for Netti II and III

Is used in order to reduce the seat width of the chair and stabilise the user's pelvis. Made of foam material.



### Comfort pads for Netti 4U CED, Base and Mobile

Used in order to reduce the seat width of the chair and stabilise the user's pelvis. 1.3 cm thick spray foam. The armrest can be swung back even when padded.



### Comfort pads for Netti 4U CE Plus

This foam pad is used to reduce the seat width by 4 cm and stabilise the user's pelvis.



### Comfort pads for Netti 4U CE

Used in order to reduce the seat width of the chair and stabilise the user's pelvis. Made of foam on wood.



### Comfort pads for Netti Mini

Used in order to reduce the seat width of the chair and stabilise the user's pelvis. Consists of 2 cm foam.



### Pelvic stabilisers

We offer a range of Netti and Bodypoint belts for stabilising the pelvis.

# NETTI ACCESSORIES



### Stable seat position with comfort seat plate

The comfort seat plate complements the pressure-relieving effect of the seat cushion and allows the pelvis to sink down further. The oval hole in the seat plate allows the ischium to sink into the cushion. This stabilises the seating position and prevents a tendency to slide forwards.



### Sliding seat

Can be recommended as an aid for simpler transfer and positioning of the user. The seat plate can be pulled out or pushed in while the user is sitting in the chair. This ensures that the user can sit right at the back of the chair. The sliding seat is well suited to persons with contracted knees or for lift users.



### Up to 9 cm seat width flexibility

The seat width of a Netti wheelchair can be adjusted by inserting comfort cushions and with the armrest extension kit, and is thus very flexible.

Netti 4U CE:	-2 / 4 cm
Netti 4U CE Plus:	+2 / 4 cm or -2 / 4 cm
Netti 4U CED:	+2.5 cm or -2 / 4 cm
Netti 4U Base:	+2.5 cm or -2 / 4 cm
Netti Mobile:	+2.5/5 cm or -2 / 4 cm
Netti III	+2.4 cm or -2.5 / 5 cm



### Seat tilt lock (seat angle lock)

Locks the seat tilt function and is recommended for restless users and for car transport.

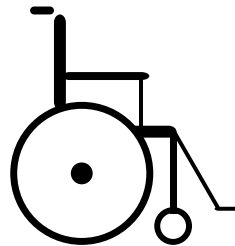

### Tilt limiter

For Netti II, III and Netti 4U family  
Reduces angular deflection forwards or backwards.



### Extension pieces with additional abduction +5 cm

For users with high abduction this is combined with a 5 cm wider footrest, and often with knee and thigh supports.

It may be advisable to use spacers on the steering wheels. Not suitable for Netti 4U CE or CE Plus.



### Abduction block

In order to prevent dislocation of the hips and compression of the knees (due to muscle tension), an abduction block may be mounted which presses the femurs apart.  
Available in four different sizes.



### Abduction belt

For positioning and stabilising the pelvis.



### Knee and thigh supports

Improves the posture of knee and thigh in cases of high abduction.



*Enable joy of life*



## Arm support

Netti wheelchairs are fitted with arm supports, which differ according to model. All Netti arm supports offer depth and height adjustment. A wide choice of armrest pads is available in order to offer the best suited individual solution.



### Arm support pad

Available in various lengths and widths

335 x 58 mm (Mini)	420 x 80 mm
385 x 58 mm	525 x 80 mm (Straight)
335 x 55 mm	525 x 80 mm (Bend)
445 x 68 mm	

### Soft padding for arm support

For the arm pads 385x58 and 420x80 we offer a soft cover in either Easy Care or 3D. For all other arm pad sizes, we can customise a cover.



### Arm support with padded half-tray for Netti II, III

Flexible arm positioning encourages good posture and allows pressure relief. The tray is adjustable for height and depth. The tray top can be folded up in order to facilitate entering and exiting the wheelchair.

### Hemiplegia arm support

Recommended for hemiplegics, rotating and fixable.

### Hemiplegia cushion

With soft Cospoflex foam fill.



## How to adjust the armsupport

- Define the inclination of the backrest
- Height adjustment: the arms aligned along the trunk, shoulder relaxed, position the forearm at 90° on the armrest providing a stable and comfortable support
- Depth adjustment: the armrest must provide optimal and even support for the forearm

## Back unit

The Netti wheelchairs offer a wide variety of solutions when it comes to the back unit. When using a specific back unit, the individual needs of the wheelchair user can be accommodated. In this way specific deformities of the spine (hyperkyphosis, scoliosis etc.) or involuntary movements of the torso (spasms, ataxia etc.) can be supported in the best possible way. An individual and good support of the torso is the base for a well-functioning head position.



### Additional back height

For tall persons, the back height can be lengthened to 60 cm. NettiSmart, Stabil and Super Stabil are available in back heights of 60 cm. If you already have a cushion of standard back height, you only need a cover with back height 60 cm. Not available for Netti 4U CE and Base.



### Back cushion with stabilising side supports

Netti Uno has 10 cm side supports, Netti Smart 12 cm and Netti Stabil 17 cm side supports. Netti Super Stabil has reinforced 17 cm side supports.

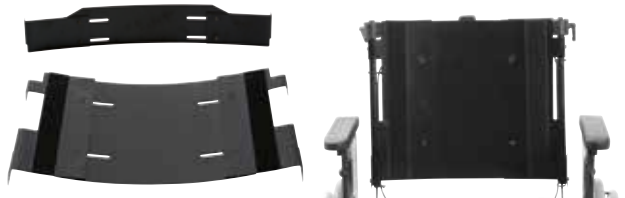

### Fixed aluminium back

For users who need a firmer backrest. Height 50 or 60 cm with back extension. For all Netti wheelchairs except Netti 4U CE and Base.



### Harnesses

In specific cases a harness may be needed. The choice of harness can support the individual goals of the wheelchair supply.



### Libertas back

15° back mobility for enhanced sitting comfort. Wheelchair users are able, without outside help, to make small stretching movements in the torso and thus satisfy their natural urge to change their seating position. Three cylinder strengths available: 80, 120 or 160 Newton.



### Netti Dynamic back unit

Flexible back which cooperates with the seat. The back adapts itself to both minor and major trunk extension movements up to a completely inclined back unit.

Dynamic gas cylinder for back angle 15°: choose from three different strength (80, 120 or 160 N)

Dynamic Free gas cylinder for back angle 40°: Lockable - choose between different cylinder strengths (200 to 1300 N).

## Stabilisation of torso

For correcting faulty or wrong postures and for limited back stability, a back wedge or lumbar cushion can be inserted between the velcro straps and the back cushion. For persons with limited stability, side supports, lateral supports or a back cushion with reinforced side supports may be necessary.



### Side support Correction

The side support Correction supports directly on the body and thereby offers extra stability together with the back cushion. The side supports are optimal adjustable with the flexible adapter and ball joint. An extra pad for the adapter is available.



### Lateral support Stabil

We offer an extra lateral support for our back cushions Netti Stabil and Super Stabil. These are adjusted on the back tube and supports the side supports of the cushion in order to offer even more stability. An extra upholstery is available.



### Side support Basic

#### For Netti 4U CE, CE Plus and Base.

The side support is adjustable in width as well as height and depth.



### Side support correction Mini

#### For Netti Mini

For our Netti Mini chair we also offer a smaller side support that is placed directly on the body of the user to offer stability. Adjustable in height and depth - an extra upholstery is available.



### Velcro back strap with cut out for mounting of side supports

Not for Netti 4U CE.

### Lumbar cushion

For easy and individual support of hyperlordosis.

### Back wedge

For improvement of posture in cases with a light degree of scoliosis.



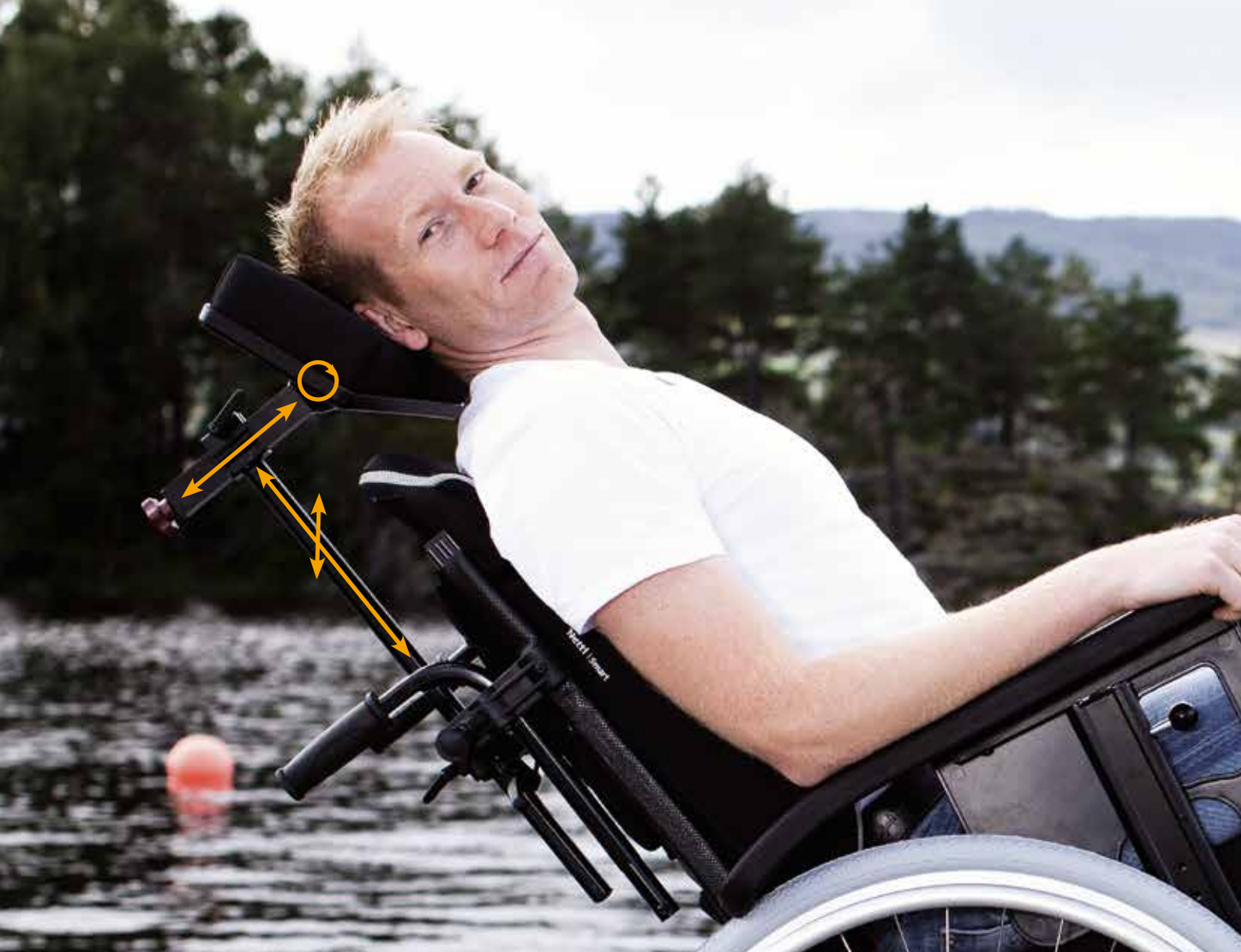

## Accessories for head support



### Removable extra cover, for head supports A, B and C.

Machine washable at 60 degrees.



### Head cushion with elastic strap

The head cushion relieves stress on the neck. The cushion is easily fixed with a rubber band.



### Comfort cushion for head support

Recommended for better posture and improved relief of head and neck when using head support C.



### Vertical bar for head support

In three different lengths

- 20 cm
- 30 cm
- 50 cm



### Horizontal tube for head support

Allows adjustment of the head support depth. Three available lengths:

- 15 cm
- 25 cm
- 38 cm



### Headrest stabilisation

Ideal for special loads on head support (e.g. spasticity or vehicle transport) Mounted on the head support adapter. Suitable for Netti II and III

## Head supports

Netti head supports can be adjusted in height, depth and sideways, in order to ensure optimum fitting.



### Head support A

For persons with limited head control and stability. Also available with forehead strap.



### Head support B

For users who need a support in tilted position.



### Head support C

Allows a change of resting position for the head.



### Head support D

Ergonomic shape supporting the natural curvature of the neck. Pressure distributing properties.



### Head support E with adjustable side supports

Side supports in the same or different length.



### Head support F with chin support



### Head support A with forehead strap

Excellent for persons with low head stability and problems with balance, or persons who need an upright head posture, e.g. for better breathing.



### Savant head support

The Savant head support is breathable and lightweight and is simply shaped with the hand. It offers a three-stage support to the head in order to control side bending and rotation. A head strap can also be fitted as a front support. Also available with extra side wing.



### Head support Mini with side supports for children.



### Axion head support adapter

Rotating adapter for head supports, permits sideways rotation of 60°. Axion allows the head support to rotate freely, thus extending the user's freedom of movement. Axion is indicated for persons with limited head control, limited freedom of movement or limited visual field. It can also be used for persons who frequently rub their head by turning it in the head support.

## NETTI ACCESSORIES

### Accessories for greater independence



#### One-hand drive

For users who can only use one hand. Please also note the one-hand brake option.



#### Spoke protection

Prevents the user's hands slipping between the wheel spokes. Transparent on delivery but may be decorated with stickers at the wish of the user.



#### Push rim cover

Recommended for users with limited gripping ability, as the rubber surface provides a good grip.



#### Release lever for seat tilt and back angle

May be mounted under the right or left armrest. If the user wishes to set the back angle and seat tilt, the handle is mounted under the armrest. Available for Netti II and III.



#### Frame extensions for Netti III, 4U and Mini

Allows the main wheels to be moved to the rear, if a longer seat depth is desired. May increase stability depending on centre of gravity. With frame extensions, longer anti-tippers and a brake on the lower frame tube are necessary.



#### Main wheels in many different sizes for different seat heights

We offer a wide range of wheel sizes in order to achieve an optimum seat height and accommodate the specific use for the chair.



## Electrical functions

For many users, electrical control of back angle, seat tilt and footrests can be of the greatest benefit and means more independence and quality of life. This allows the user the opportunity to change seat position at any time. Electrical functions can be mounted on the Netti II and III chairs.



### Electric seat tilt

For Netti II and III

### Electric back adjustment

For Netti III

### Electric upper leg support parts

For Netti II and III



### Manual operation

Visual symbols for simple understanding and operation.

### Manual control holder

Recommended if the user will be operating the electrical functions.

### Electrical kit

In certain configurations, a manual Netti II or III can be converted into an electric model. We shall be pleased to provide detailed advice about this accessories kit.



*Enable joy of life*

# NETTI ACCESSORIES

## Netti out and about



### Fixation kit

Recommended for car transport.



### Anti-tipper with pedal

Standard for Netti III family. Option for the Netti 4U family.

Aid for overcoming an obstacle. Can be swivelled upwards when chair is pushed by an attendant. The anti-tipper is adjustable in height and depth.



### Wheelchair bags

For convenient storage. Can be used on all Netti wheelchairs.



### IV stands

IV stands for drips, artificial nutrition and medicinal treatment. The IV stand is mounted on the push bars and supplied with two removable hooks.

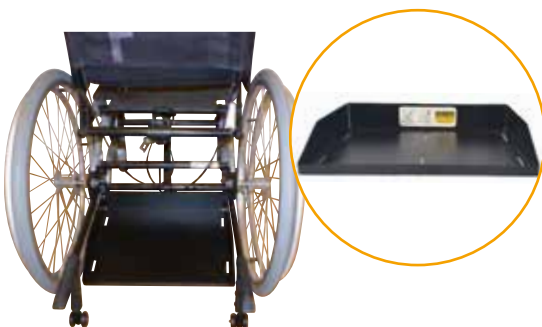

### Universal device basket

This Universal device basket permits the flexible use of different medical devices or other transport goods on the Netti 4U CED, Netti 4U CED XL or Netti 4U Base. See page 79.



### Universal device rack

For accommodating oxygen or aspiration devices in the Netti III family, Netti Mobile family and Netti Mini. See page 78.



# Universal device rack or basket for better mobility and independence

## Universal device rack

For use of oxygen devices or aspirators, etc. A flexible solution with adjustable system for secure fixing of medical devices. Compatible with most devices. Available for seat widths of 35-75 cm.

The opening in the bottom of the universal device holder is rectangular with a 180° rotatable insertion profile allowing it to accept a round oxygen cylinder.

An additional cover plate is available as an option. This will provide a further surface for use as an additional device carrier.

Devices are secured by angle brackets. Additional angle brackets can be purchased in sets of four. The maximum load is 10 kg.



Transporting medical devices is very risky, so a secure and reliable solution is important. Medical device manufacturers have very precise rules about how to transport them (e.g. firmly fixed, horizontal, free cable access, free field of vision, etc.) Netti's universal device carrier has been exhaustively tested in accordance with the rules of the German Medical Devices Act. The carrier may be fitted on the following products: Netti III HD, Netti III XHD, Netti Mobile, Netti Mini.

**NETTI III HD**  
**NETTI III XHD**  
**NETTI MOBILE**  
**NETTI MINI**

## NETTI ACCESSORIES



**NETTI 4U CED**  
**NETTI 4U BASE**

### Universal device basket

This Universal device basket permits the flexible use of different medical devices or other transport goods on the Netti 4U CED, Netti 4U CED XL or Netti 4U Base. The

chair is configured with a frame extension and extra-long tipping supports. The maximum load on the universal transport carrier is 6 kg.



## Brakes and brake handles

Different types of brake are available on Netti wheelchairs. The standard brake is mounted on the frame tube and acts directly on the wheel. If the user is unable to operate the brake, a drum brake/attendant brake should be mounted. This brake is mounted in the hub of the main wheel. For users with limited mobility or strength in the fingers, a longer brake lever can be mounted on the wheelchairs. A one-hand brake is also available on Netti III.



### Drum brake

Available for attendants on all chairs.



### One-hand brake

For users who can only use the brake on one side, we offer a drum brake with brake cable operated by the user's brake. On request we can offer a mechanical central brake.



### Longer brake lever for Netti II, III, and 4U

For better brake operability, a longer brake lever may be used. This also makes the brake easier to operate by persons with limited strength.

150 mm Netti I, II, III

250 mm Netti I, II, III

310 mm Netti 4U

## Push handles and push bows



### Push handles

Available in lengths of 30 or 50 cm. The standard length is 30 cm.



### Height-adjustable push bow

Recommended for users who are pushed by an attendant. Allows the simple adjustment of height and angle if several persons of different heights are to push the chair.

# NETTI ACCESSORIES

## Trays for activity and relief

Trays and arm supports have various functions in the context of the individual supply of a comfort wheelchair. As a bearing surface close to the body for supporting the upper extremities in hemiparesis or tetraparesis. As a working platform for rehabilitation care or as an area for placing food, drinks, etc.



### Reinforced and swivel-mounted

The tray is easily swivelled to the side to make transfer or access easy for the user. The tray can be locked in the desired position



### Reinforced and lockable

Locking permits safe positioning of the tray.



### Universal

Merely pushed over the arm supports. From size 55 cm, there are corners in the sides as well as at the front.



### Reinforced

Easily attached and detached with a stable tray top.



### Tray pad

Where the tray is used for long periods, a soft pad should be fixed to the tray top. The pad consists of soft foam with an easy-clean Skai artificial leather cover. Fixing with Velcro fastener.



### Padded half-tray for Netti II and III

Flexible, retractable arm positioning system encourages good posture and allows pressure relief. The tray is adjustable in height and depth.



### Wide arm support pads

Where a wide armrest pad is used, it may be necessary to use a wider tray. Further information is available from our Customer Service.

# Rim controlled drive unit for easy self propulsion

E-Move is the first push rim controlled drive unit on the market that can be adapted to the user's actual needs. The user simply has to drive as straight as possible for a maximum of 50 seconds. With one click of the programming software, E-Move recommends the optimum settings for the user. Small adjustments can easily be made to the parameters if required. Whether the user has disbalanced arm strength, can use only one arm, is in need for (different) sensitivity in either push rim, additional power either forwards or backwards or turning sensitivity, it is very simple to customise.

The "second driving profile" option allows users to easily change the driving characteristics. Any changes that the user needs can be assigned to this function, so it is not just "indoor" or "outdoor" although also very usefull in these situations.



### **No need to think about any imbalance in arm strength or other specific characteristics**

Programming software for E-Move allows you to fine tune the parameters.

Safety is always of highest importance. Therefore, all settings for the right wheel are backed up on the left wheel and vice versa. Calibration has never been so easy. Calibrate both wheels within one minute. It is not only quick, it is secure, extremely accurate and durable.

It is available in a standard version for max. user weight of 130 kg and a heavy duty version for a max. user weight of 150 kg.





## Specifications

<b>Motor</b>	Yamaha motors: AC servomotor, 24V 110W
<b>Batterytype</b>	NiMH, 24 V, 6.7 Ah, (160.8 Wh) range 20 km Option: Li-ion, 25 V, 11.8 Ah (280 Wh) range 35 km
<b>Wheel</b>	7 kg
<b>Total weight</b>	17 kg (including NiMH battery) 18 kg (including Li-ion battery)
<b>Total chair width</b>	Netti 4U CED: Seat width approx. + 22 cm Netti III Family: Seat width approx. + 26 cm E-Drive increases the total width with approx. 4 cm
<b>Wheel dimensions</b>	20", 22", 24" or 26"
<b>Air pressure</b>	6 Bar, 600 kPa
<b>Speed</b>	0–6 km/h
<b>Maximum range with fully charged battery</b>	Approx. 20 km with NiMH battery Approx. 35 km with Li-ion battery in accordance with ISO 7176-4
<b>Fuse</b>	30A (flat)
<b>Max user weight</b>	130 kg
<b>Max user weight "Heavy-duty"</b>	150 kg
<b>Max gradient</b>	6°
<b>CE mark</b>	Complies with EU-Directive 93/42/EEC
<b>Battery charger</b>	100 to 240V AC, 50/60H
<b>Estimated effect</b>	37V 26A (when charging)
<b>Rated power charging time</b>	Normal charging time approx. 2–3 hours NiMH & Li-ion. Service charge NiMH: 3-13 hours, full capacity (once every 13-26 charges)

### What do I get when I order E-Move?

- Two motor-driven wheels in size
- 20", 22", 24" or 26" pneumatic wheels
- Stainless steel push rims
- On/Off button on the right side
- Battery + battery charger
- A battery case for mounting behind the seat
- User manual
- Two-year warranty
- Programmable according to unique needs:
  - Extra power forwards (0-100%)
  - Extra power reverse (60-100%)
  - Rotation sensitivity
  - Hemiplegia (one-hand operation)
  - Left push rim sensitivity
  - Right push rim sensitivity
  - Correction of imbalance in arm strength
  - Adjustable speed limitation

# Easy propulsion with joystick or attendant control

Experience the freedom of E-Drive and make your everyday life easier. It can be controlled easily using a joystick or be equipped with controls for attendants. E-Drive is equally suited to indoor and outdoor use.

The E-Drive allows individual customisation, which adds quality for the user. You can easily adjust parameters for acceleration, speed reduction, turning sensitivity, joystick sensitivity or the three different driving styles: sport, standard or soft, using the joystick or computer software.



### Make your everyday life easier

E-Drive will give you more freedom and make your everyday life easier. The many configuration options secure an optimal driving experience and handling. The chair is easily driven - indoor as well as outdoor.

It is available in a standard version for max user weight of 125 kg and a heavy duty version for a max user weight of 150 kg.



## Specifications

<b>Motor</b>	Yamaha motors: 24V 120W
<b>Batterytype</b>	NiMH battery, 24V x 6.7Ah - range 15 km Option: Li-ion battery, 25V x 11.8Ah - range 35 km
<b>Wheel</b>	7 kg
<b>Total weight</b>	16 kg (including NiMH battery) 17.5 kg (including Li-ion battery)
<b>Total chair width</b>	Netti 4U CED: Seat width approx. + 22 cm Netti III Family: Seat width approx. + 26 cm E-Drive increases the total width with approx. 4 cm
<b>Wheel dimensions</b>	16", 20", 22", 24", 26"
<b>Air pressure</b>	6 Bar, 600 kPa
<b>Speed</b>	0-6 km/t
<b>Maximum range with fully charged battery</b>	Approx. 15 km with NiMH battery Approx. 35 km with Li-ion battery in accordance with ISO 7176-4
<b>Fuse</b>	30 A (flat)
<b>Max user weight</b>	Up to 125 kg
<b>Max user weight "Heavy-duty"</b>	Up to 150 kg Rims and spokes are made from a stronger material
<b>Max gradient</b>	6°
<b>CE mark</b>	Complies with EU-Directive 93/42/EEC
<b>Joystick</b>	Contactless sensing by single-chip Standard fitted on right side on a swing-away arm.
<b>Force alteration</b>	By optional spring (for individual optimization)
<b>USB charger</b>	Auxiliary USB port (5V, 500 mA max.)
<b>Display device</b>	LCD (Vertical aligned)
<b>Parameter setting</b>	Onboard (joystick) / via PC (Smart Tune)
<b>Battery charger</b>	100 to 240V AC, 50/60Hz (standard) A power converter for car is available as accessory.
<b>Rated power</b>	37V. 26A (when charging)
<b>Charging time</b>	Normal charging time approx. 2-3 hours

### What do I get when I order E-Drive?

- Two motor-driven wheels in size 16", 20", 22", 24" or 26"
- Two anodised aluminium push rims
- Anti-tip
- Easy programming via a joystick
- Battery + battery charger
- A battery bag is included when you choose a battery that fits under the seat or behind the seat back
- User manual
- Two-year warranty



## Prevent pressure ulcers with reliable data

Once a decubitus ulcer has developed, wheelchair users can face painful treatments, months of bed rest, hospitalisation, and in the worst cases, sepsis. An effective pressure redistribution strategy is key to the prevention of pressure ulcers. It is now easier than ever to identify the high pressure points that can indicate the area with the risk of pressure ulcers. XSensor® offers the newest generation of wheelchair pressure mapping technology.

**XSENSOR**® Technology Corporation  
Innovators in Pressure Imaging™

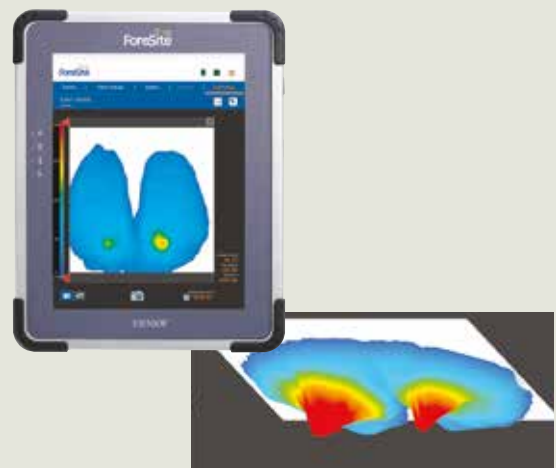

### The LX100 Sensor

ForeSite SS shows exactly where the pressure is that needs relief. With 1296 sensor points on a 45x45 cm sensor, no other sensor is as accurate as the LX100.

The LX100 is with its 4x higher accuracy than its nearest competitor the most precise pressure sensor worldwide. ForeSite SS does not only show the elevated pressure, but also exactly how high the pressure is on the sensor thereby giving you convincing treatment strategies.

The LX100 is very thin, flexible and light. The pad conforms easily to the chair's seat and back, giving you an accurate view of the pressure distribution on the seat.

- Flexible sensor pad embedded with thousands of sensor cells that continuously measure the patient's body surface pressures.
- Touchscreen tablet that displays real-time images of elevated pressures.
- ForeSite SS software that clearly shows the various pressures applied to the sensor pad - highlighting higher or lower values in the pressure distribution.

### ForeSite SS Benefits

- Wireless communication (Bluetooth) between sensor and tablet.
- The medically-certified tablet is light, modern and easy to use software is installed - you can be up and running within minutes.
- Heightened data security: Data encryption.
- Intuitive, user-friendly interface: New software is simple to learn and allows the user more control over client files.
- Capture and manage still frame images and recordings: Valuable for clinical reporting.
- Easily transfer data and images: Generate reports within the software — data sharing and transfer between users is greatly simplified.
- Very accurate sensor: Factory calibrated LX100 sensor.
- WiFi network connectivity: Enables users to send data via email.

# XSENSOR FORESITE SS

## A powerful and easy-to-use system

ForeSite SS is a powerful, and easy-to-use system for the measurement of bodysurface pressures that are a key factor in the development of pressure ulcers. Designed for seating professionals, ForeSite allows therapists to record and analyse interface pressure data - providing the information they need to develop an effective pressure relief strategy. In addition, patients can use the visual feedback provided by ForeSite to learn ways that they can relieve these pressures. Delivered with the LX100 - a durable, cleanable, factory calibrated sensor - ForeSite SS provides the accuracy and resolution required by rehabilitation specialists.



### The product spectrum of the ForeSite SS includes:

- Optional Touchscreen Tablet 9,7" ready to use
- ForeSite SS desktop Software on Supplied USB
- Power supply
- Soft carry case
- For wheelchair measurement: 1 or 2 Wireless Sensors
  - Spatial Resolution: 0,5" (12,7 mm)
  - Pressure Range: 0,07-2,7 N/cm<sup>2</sup> (0,1-3,87 psi)
  - Calibration: ISO/IEC 17025 Accredited
  - Accuracy:  $\pm$  5% full scale
  - Sampling Frame Rate: 4 frames/s
  - Ingress Protection: IP55 dust protected, water jets
  - Cleanability: TIR30

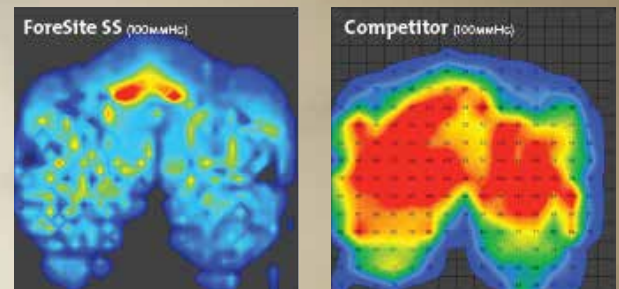
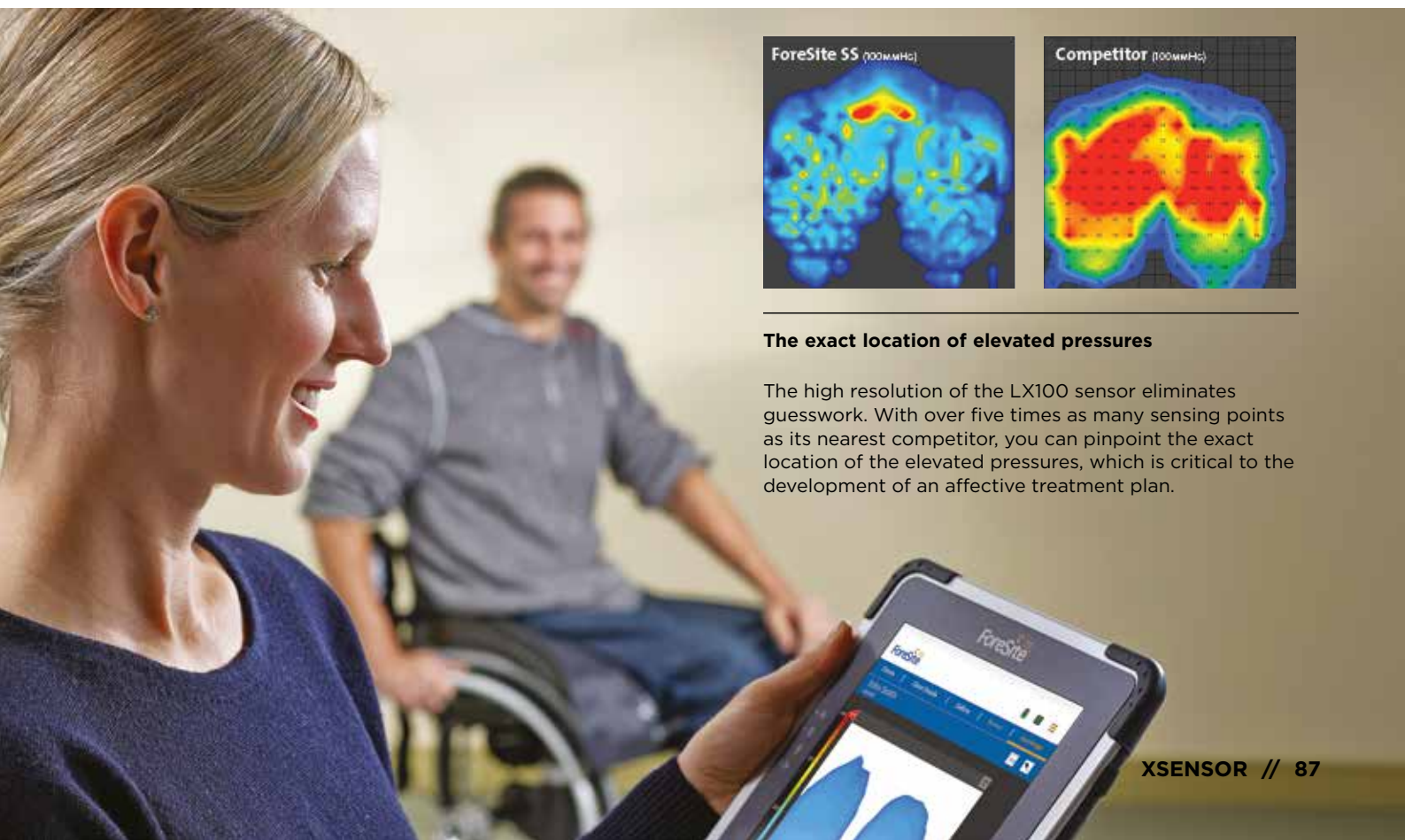

### The exact location of elevated pressures

The high resolution of the LX100 sensor eliminates guesswork. With over five times as many sensing points as its nearest competitor, you can pinpoint the exact location of the elevated pressures, which is critical to the development of an effective treatment plan.



*Enable joy of life*



# RAMPS

## Simple to fold- easy to handle



The ramp is folded in the middle and is convenient for transport. It has a width of 80 cm and a continuous running surface.

The ramps are the lightest on the market and available in lengths of 61, 92, 122 and 152 cm.

All ramps are of aluminium construction and have a top-quality non-slip coating.



Ramp width  
80 cm



Ramp length  
61-152 cm



Max. load 300 kg



Weight  
4.5-10 kg

## Multifold ramp – the innovative wheelchair ramp

With a new and patented hinge joint which allows the ramp to be divided into two tracks if desired. This gives the ramp optimum stability under maximum load conditions. The ramp folds up and can be transported like a normal suitcase, thus easing storage and transport.

All ramps are made from aluminium and have a top-quality non-slip coating. They have an ideal width for wheelchairs of 80 cm. Lengths available: 152, 183, 213, 244, 305 and 366 cm.



Ramp width  
80 cm



Ramp length  
152-366 cm



Max. load  
152-213 cm, 300 kg  
244-366 cm, 250 kg



Weight  
13.6-33.3 kg



## Cushion and chair design work together

The Netti cushions complement many of the functions of the Netti wheelchairs. Together they create an optimum solution with multi-point pelvic stabilisation, optimum freedom of movement of the torso and excellent pressure distribution.

The seat and back system from Ride® Designs expand our previous product solutions and meet the highest demands and needs of our users. On the one hand they support an individual approach to the specific wheelchair supply, on the other hand they are extremely convincing in the way of easy and practical handling. All in all a perfect supplement to our Netti products.

*Enable joy of life*

## **NETTI SEAT CUSHIONS**

High-quality foam cushions with good pressure distributing features.

See page 94



## **NETTI BACK CUSHIONS**

Individual and adaptable solutions for more trunk control and an improved seating position.

See page 96



## **RIDE® DESIGNS SEAT CUSHIONS**

An innovative concept for the highest demands.

See page 100

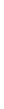

## **RIDE® DESIGNS BACK SYSTEMS**

A combination of maximum stability and highest possible individualisation.

See page 102





*Enable joy of life*

## Cushions with unique solutions

- Ready for immediate use
- Optimum pressure distribution
- Optimum ventilation
- Temperature-stable
- Stabilising properties
- Back cushion with simple, stable Velcro solution
- Height-adjustable back cushions
- Wide range of seat widths
- Lightweight
- Designed for ease of transfer
- Washable and environmentally friendly



# True stability for enhanced activity



## Netti Uno Seat

Multi-layer seat cushion with good pressure distribution.



## Netti Sit

Multi-layer seat cushion with integrated side support, waterproof intermediate cover and good pressure distribution.



## Netti Contour

The cushion shape matches the body and offers excellent stability and user support.



## Netti Dry

Hygienic Easy Care cover, suitable for all cushions.



## Ride® Forward

For users with special requirements for support.



## Ride® Java Seat

Reduces buildup of heat and humidity. Very high sitting stability. Also for users with medium to high skin risk.



## Netti Kyphotic

Specially developed multi-layer back cushion for persons with kyphosis.



## Netti Uno Back

Single-piece foam cushion with integrated side supports. Simple height adjustment.



## Netti Smart

Excellent pressure distribution and 12 cm side supports. With optical design elements for simple positioning.



## Netti Stabil

A back cushion similar to Netti Smart but with longer side supports - 17 cm. For users with unstable lateral posture.



## Netti Super Stabil

For users with special requirements for support. Similar to back cushion Netti Stabil, but with reinforced side supports.



## Ride® Java Back

Adjustable backrest inclination and individually adapted pelvic shape offer balanced support with simultaneous freedom of movement.



## Ride® Java Decaf back

Noticeable support with all the adjustment options of the Ride® Java backrest and more besides, specially developed for children.

# NETTI SEAT CUSHIONS

## Netti Sit

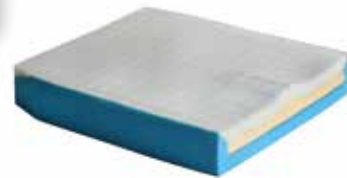

Sliding forward is prevented by the use of a softer foam at the rear end of the intermediate layer.

The integrated abduction block improves the seating position.

Side supports provide more stability and contact surface.

A flexible material improves the bearing capacity of the bottom layer and reduces the total weight.

A firm foam in the front and middle layer stabilises the thigh and the front edge of the seat cushion.

The cut top foam reduces surface tension and ensures that the user sinks quickly into the cushion, thus rapidly distributing the pressure.

The high bearing capacity of the bottom layer prevents pressure sores and increases stability.

- Ready for immediate use!
- Good pressure distribution and stabilising properties.
- Ready adjusted to the user on delivery - no adjustments and adaptations required.
- Delivery with waterproof but breathable intermediate cover to protect the foam cushion (for 3D cover).
- The foam properties are adapted to the cushion size - and thus to the user's weight.
- Breathable 3D, easy-to-clean Easy Care or temperature-stabilising °C covers.



**°C**  
Temperature-stable, breathable, elastic and wear-resistant. Temperature-stabilising fabric under the 3D cover. This fabric stabilises at 32°C, i.e. it gives off heat or insulates when the temperature rises above or falls below this limit. The °C cover slows down and reduces the heating process in the skin and tissue.

Seat width

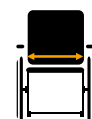

25-75 cm

Seat depth

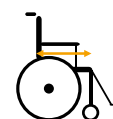

30-55 cm

Height



8 cm

# NETTI SEAT CUSHIONS

## Netti Uno Seat



- Ready for immediate use!
- Ready adjusted to the user on delivery – no adjustments and adaptations required.
- The foam hardness is adapted to the cushion size – and thus to the user's weight.
- Breathable 3D or wipeable Easy Care covers.

Soft upper foam ensures rapid sinking of the body into the cushion, quickly distributing the pressure.

A firm foam in the front and middle layer stabilises the front edge of the seat cushion.

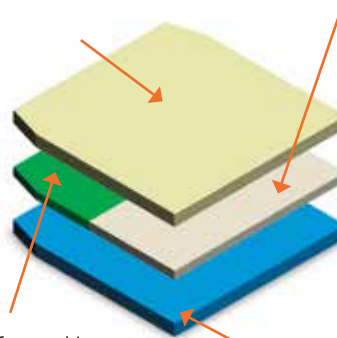

Sliding forward is prevented by the use of a softer foam at the rear end of the intermediate layer.

The bottom foam with a higher specific weight prevents pressure sores.



Seat width

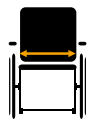

35-60 cm

Seat depth

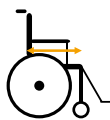

40-50 cm

Height



8 cm

## Netti Contour



- The contour of the cushion matches the body and offers good support and sitting comfort.
- Ready for immediate use!
- Good pressure distribution and stabilising properties.
- Breathable 3D cover.
- The combination of non-slip textiles and Velcro strips under the cushion allows its use in practically every wheelchair.

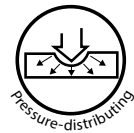

Seat width



35-50 cm

Seat depth



35-50 cm

Height



6 cm

## Netti Dry



- Hygienic Easy Care cover
- Suitable for all seat cushions
- Maintains the pressure-distributing and ventilating properties of the cushion
- Ready for immediate use



Seat width



25-60 cm

Seat depth



30-55 cm



## NETTI BACK CUSHIONS

### Properties of the Netti back cushion



- Soft foam ensures effective sinking of the body and good pressure distribution.
- The unique design offers freedom of movement to the shoulders.
- Freedom of movement to the arms, thanks to the low side supports.
- Breathable 3D cover
- Lots of room for the hip area in order to ensure a stable seating position.
- 10, 12 or 17 cm side supports – depending on cushion design
- Ergonomically shaped and precisely positioned lumbar support for better body stability.



The rear side has a flip-over section with Velcro fastener, fixing the cushion in the desired position. The chair also looks attractive from the rear. Integrated storage bag. The lower part of the flip-over can also be positioned under the seat cushion in order to cover the gap between the back and seat cushion.



The rear side is marked with 6 half-moons in order to allow the exact adjustment of the cushion's horizontal position. This system also ensures the correct positioning of the cushion after laundry, etc.



If you already have a cushion with back height 50 cm, you only need to buy a 60 cm cover and a backrest extension. Use of the chair by a new occupant is thus easy and economical. Netti Smart, NettiStabil and NettiSuper Stabil are offered with a 60 cm back height.

# NETTI BACK CUSHIONS

## Netti Kyphotic



- Ready for immediate use!
- For users with a curved spine.
- Support along the spinal column.
- Multiple foam layers enable better sinking of the body.
- Low lateral support
- Steplessly adjustable for height to match individual needs.
- The back cushion combined with the back velcro straps offers a better upright seating position, thus improving food intake and breathing and increasing activity levels.
- Height 50 cm (can be individually adapted)

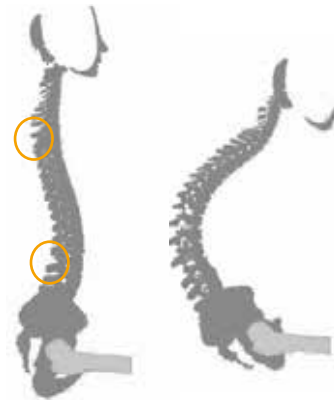

- Ergonomically shaped to match the distortion of the spine. In the central section, there is an opening for allowing maximum pressure relief along the spinal distortion.
- Low lateral support with ventilated 3D covers. The low lateral support ensures comfort and freedom of movement to the shoulders and arms.
- By removing the lower part of the surface, the cushion can be positioned and aligned directly on the seat cushion.
- The unique design offers freedom of movement to the shoulders.
- Multiple-layer foam core (PU) with pressure-relieving properties. MARS textile/fabric with excellent ventilation and elasticity properties.
- Elastic fabric allows the user to sink into the cushion and take advantage of the good pressure distribution properties.
- Specially designed for the lower part of a distorted spine.

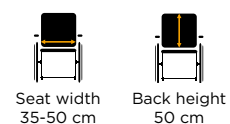
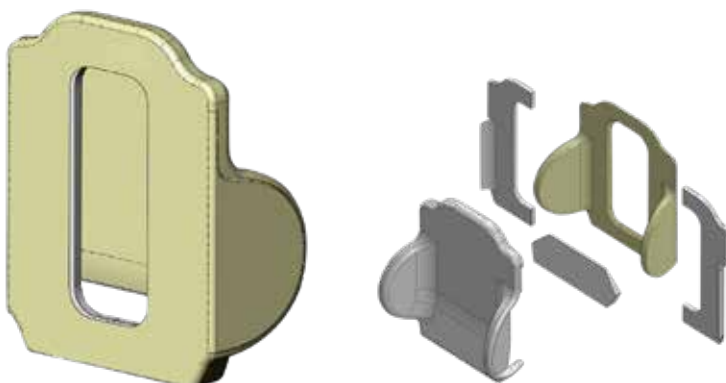

# NETTI BACK CUSHIONS

## Netti Uno Back



- Ready for immediate use!
- Good, solid back cushion with lumbar support.
- 10 cm side supports.
- Steplessly adjustable for height to match individual needs.
- Back height 50 cm
- Breathable 3D or easy-to-clean Easy Care covers.

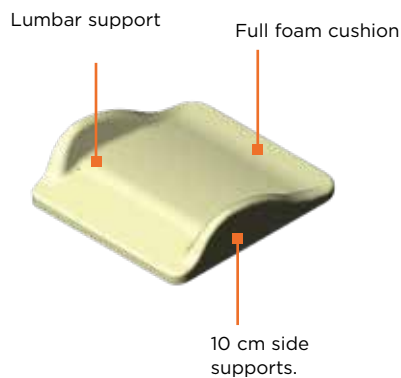
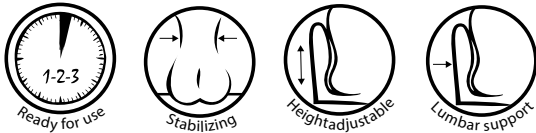
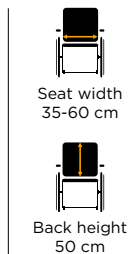

## Netti Smart



- Ready for immediate use!
- For users with higher requirements for comfort.
- Multiple foam layers.
- Ergonomic lumbar support.
- 12 cm side supports.
- Steplessly adjustable for height.
- Back height 50 or 60 cm.
- Back height 40 cm for Netti Mini (in black or black/red).
- Lots of room for the hip area in order to ensure a stable seating position.
- Ergonomically shaped and accurately positioned lumbar support for enhanced stability of the torso.
- Breathable 3D or easy-to-clean Easy Care covers.

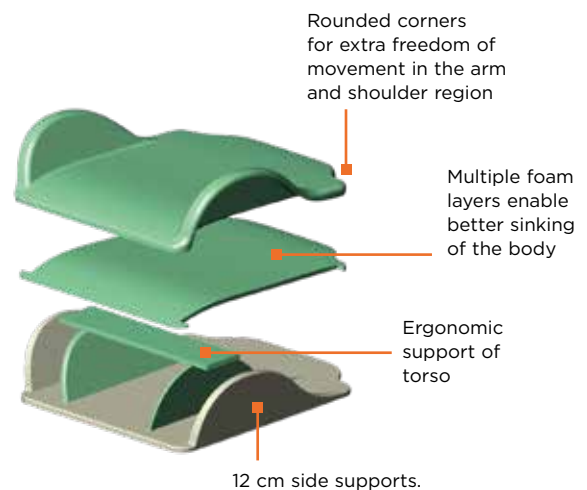
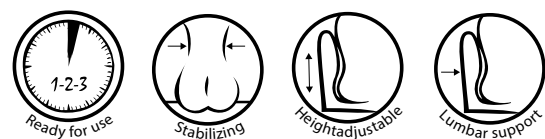
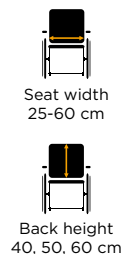

# NETTI BACK CUSHIONS

## Netti Stabil



- Good, individual adjustment options.
- For enhanced comfort and well-being.
- Multiple foam layers enable better sinking of the body.
- Ergonomically shaped and accurately positioned lumbar support for enhanced stability of the torso.
- 17 cm side supports for greater stability.
- Lots of room for the hip area in order to ensure a stable seating position.
- Good combination options with side supports Stabil.
- Steplessly adjustable for height to match individual needs.
- Back height 50 or 60 cm.
- Back height 40 cm for Netti Mini (in black or black/red).
- Breathable 3D or wipeable Easy Care covers.

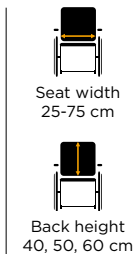

## Netti Super Stabil



- Ready for immediate use!
- For enhanced comfort and stability.
- Multiple foam layers – better sinking of the body.
- 17 cm reinforced side supports for greater stability.
- Good combination options with side supports Stabil.
- Steplessly adjustable for height to match individual needs.
- Back height 50 or 60 cm.
- Comes with two pads for adjustment of lumbar support and side support as well as adaptation for light scoliosis.
- Breathable 3D or wipeable Easy Care covers.

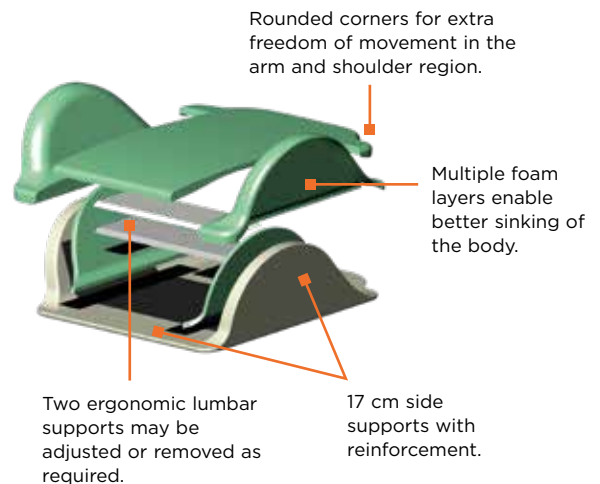
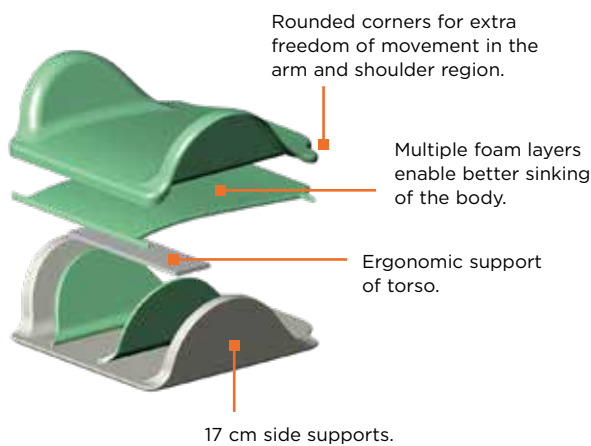
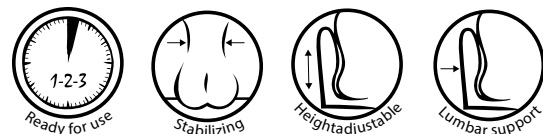
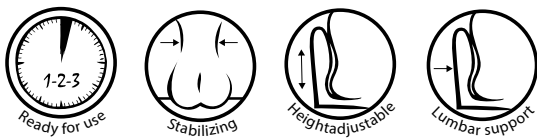
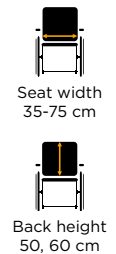



# Offload principle - rethink seating strategies

The principle behind the seat cushions from Ride® Designs is an intended pressure loading and off-loading of specific body areas.

The pelvis is an area with very sensible areas, where the bony prominences are covered with thin skin tissue. These are the ischial tuberosities, the great trochanters as well as coccyx and sacrum. For many wheelchair users these areas are prone to redness, skin damages and ulcers. Therefore these high-risk areas need to be relieved - offload principle.

On the other side areas like the proximal thigh or

the buttocks muscles can better tolerate pressure because of a thicker tissue covering the bones. Through a specific construction of the seat cushion, these areas have a defined loading of pressure - onload principle.

University studies have shown compelling evidence in support of Ride® Designs off-loading principle in concerns of pressure relief and distribution, reach and tissue compression.

## Comparison of different solutions

Two recent university-level research studies provide compelling evidence in support of Ride® Designs' off-loading philosophy.

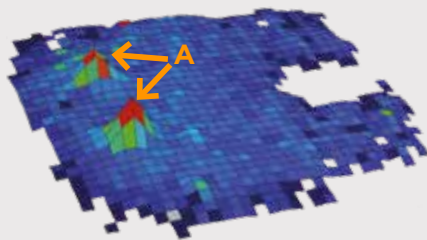

### Properly-inflated air cushion

Problem: columns of air lack the stability needed for postural control, and peak pressures tend to be at the high risk bony prominences, especially the ischial tuberosities (a).

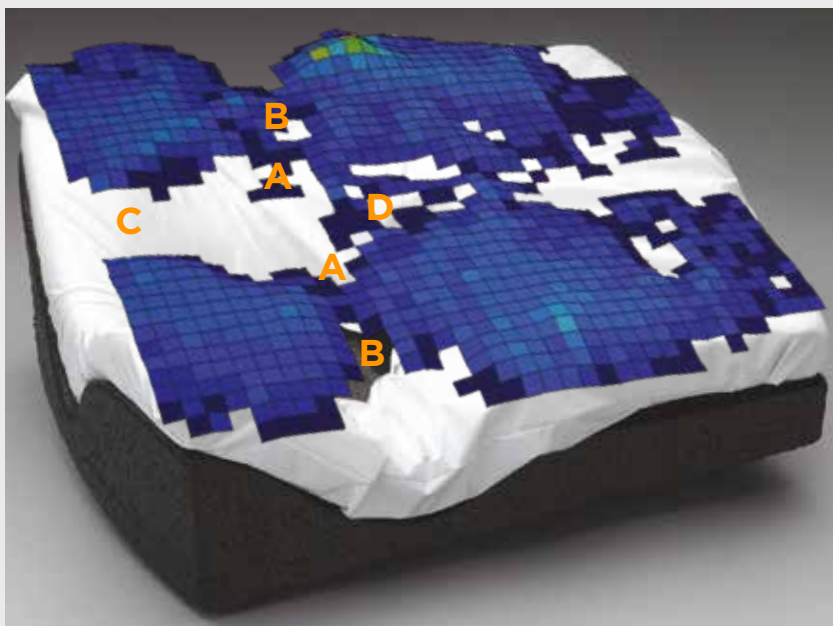

### Java Cushion

Solution: Safe and stable support of low risk areas and off-loading of high risk areas:

- A. Ischial Tuberosities (ITs)
- B. Greater Trochanters
- C. Coccyx/Sacrum
- D. Perineum(Groin)

## Skin protection and position control

### Ride® Forward

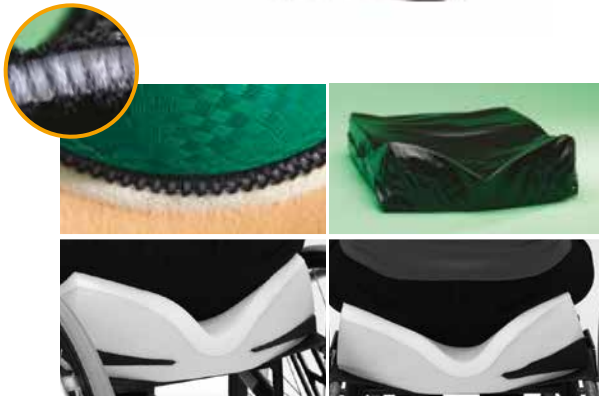

### Ride® Java Seat



- The cushion made of visco-elastic foam conforms to the individual body shape and provides optimal pressure distribution.
  - The high-quality cover with the breathable spacer fabric outer cover contributes to an optimal moisture and air circulation.
  - Ride® Designs' patented off-loading concept contributes to pressure relieve and still provides improved posture and balance. Added wedges can be used to further adjust the cushion if needed e.g. for asymmetries.
  - The Ride® Forward cushion is suitable for users with moderate to a higher degree postural challenges because of the stabilising and pressure distributing features.
- Seat widths 25 to 50 cm
  - Seat depths 25 to 50 cm

- An almost complete pressure relief of the high risk areas is achieved through the special design with cut out for the bony prominences.
  - The design of the cushion with a firm base and a softer top foam combines pressure relief with good sitting stability.
  - When sitting on a Ride® Java, the risk for tissue compression and the resulting skin risk is distinctly reduced.
  - For further adjustment lateral/ medial wedges or a well insert can be applied.
  - Although highly adjustable, the Java cushion is easy to use and offers enhanced sitting performance without the need for regular fit-essential maintenance.
  - A vented base design, contoured top foam, and a breathable spacer mesh fabric cover work together to help keep skin cool and dry.
- Seat widths 35 to 50 cm
  - Seat depths 35 to 50 cm

## Biomechanically designed

Java's patented design provides the flexibility to accurately fit the trunk and pelvis for superior support, comfort and mobility.

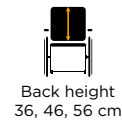

- The Java Back's patented biomechanical design provides the flexibility to easily and independently optimize pelvic support and balance the trunk, supporting the normal rhythm and movement of the body. The user experiences comfort and stability at rest, and no interference with function and mobility.
- The Java Back can be flexed specifically to support the unique contours of the user's body without loss of seat depth and to provide accurate supportive contact through the pelvis, lumbar and thoracic spine.
- The slim design and the use of high-value materials supports an improved air circulation.



### Target group

- Mild to moderate postural asymmetry
- Need for considerable assistance with trunk balance and support
- Can be combined with all Netti wheelchairs except the Netti 4U CE.



### 3 heights and 2 depths available in each size

- Depth Regular = 7,5 cm, Deep = 15 cm

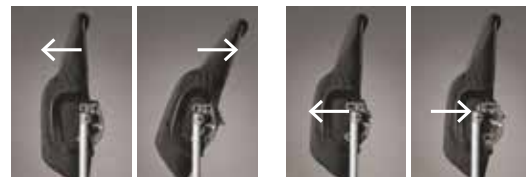

### Easy adjustment to the user

- 20° back angle
- 5 cm seat depth

## Unprecedented flexibility for precision fit

The Java Decaf Back's patented biomechanical design provides maximum flexibility through the special fitting. Adjustable in height, depth, angle and rotation to meet and stabilise severe postural indifferences. The Java Decaf Back is most effective when combined with a Ride® wheelchair cushion.



Seat width  
25-37,5cm



Back height  
Regular: 25/30 cm  
Tall: 32,5/37,5 cm

- Supports individual contours
- The Decaf Back can be specifically fitted to the child regardless of his wheelchair width
- A spacer fabric cover promotes air circulation and wicks moisture away from the back.
- The Decaf Back shares all the adjustable features of the Java Back, plus a few extra to meet the specific needs of growing and developing children.



### Target group

- Pediatric users with mild to moderate postural asymmetry
- Need for considerable assistance with trunk balance and support
- Can be combined with all Netti wheelchairs in the seat widths 25-35 cm.



Height adjustment



Rotation



Seat depth



Back angle



*Enable joy of life*

# 'Enable joy of life' - why is this so important to us?

This is the most important reason for our being!

Daily life ought to bring joy. To our employees, our dealers and in particular to the wheelchair users that are supplied with our products and for whom we constantly develop improved solutions.

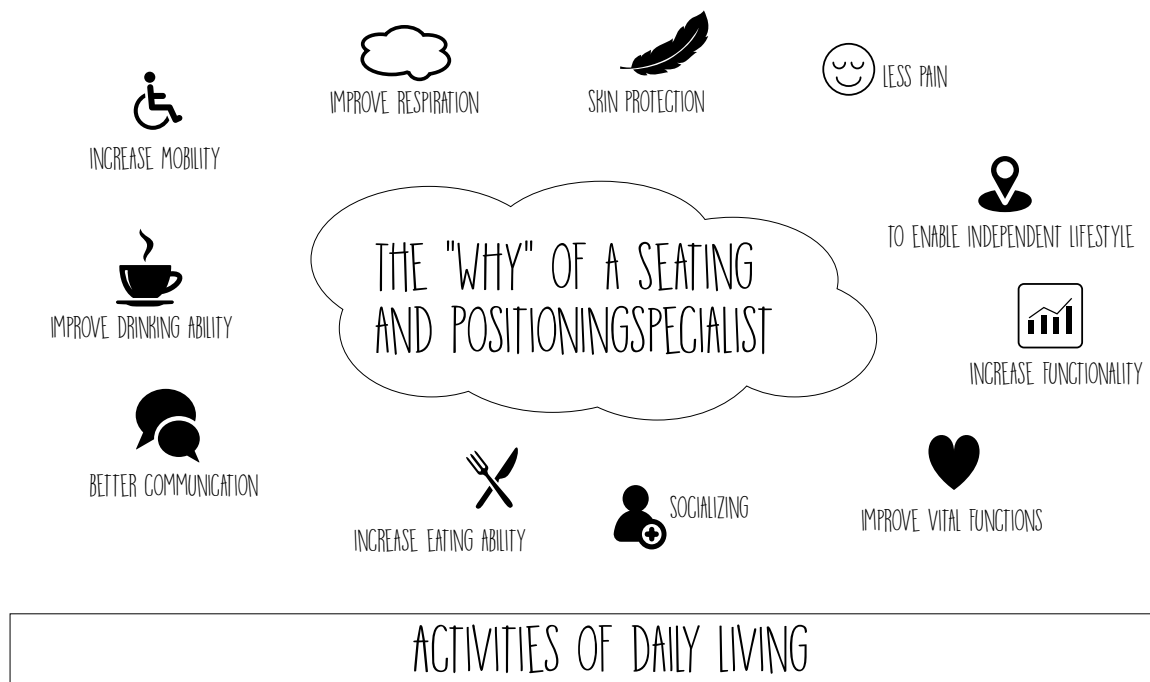





Designed in Norway

The Trollstigen (Norwegian for The Troll Ladder)  
One of the most popular tourist routes in Norway with 11 hairpin bends.

To climb Trollstigen takes time – just as finding the right solution for your customer. We believe in finding the right solution at the right time, even though the road to the right solution might be long and challenging. Feel free to contact us for support, suggestions and solutions.

Copyright: Anton\_petrus' 123rt.com



## We are dedicated to help

We are proud to be a Scandinavian group and the pioneer within wheelchairs for long term seating focusing on delivering high quality products and services to our dealers and the end-users. It is very important for us, that we can supply the end-user within a short time frame, and you will therefore experience, that we have a large inventory of different components and accessories, so that we can ship accessories as well as many complete wheelchairs within 1-5 days.

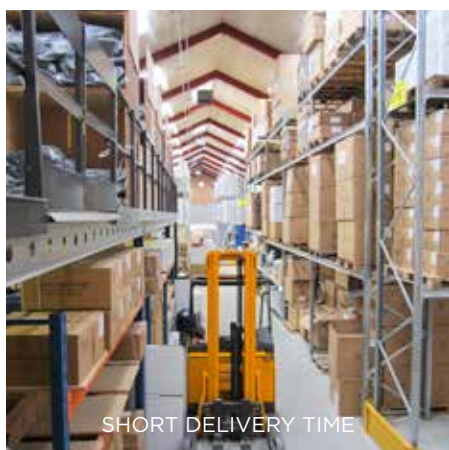

The Netti wheelchairs are manually assembled according to the end user's needs and tested and checked before delivery to the dealer. We operate according to a precisely defined quality system to constantly innovate and improve and are certified according to ISO 9001 and ISO 13485 for medical devices. All our chairs carry the CE marking.



**FEEL FREE TO CONTACT US:**

NORWAY

Alu Rehab AS  
Bedriftsveien 23  
N-4353 Klepp stasjon

T: +47 51 78 62 20  
post@My-Netti.com

DENMARK

Alu Rehab ApS  
Kløftehøj 8  
DK-8680 Ry

T: +45 87 88 73 00  
F: +45 87 88 73 19  
info@My-Netti.com

*Enable joy of life*

